

MOVING YOU FURTHER

HX140LC

Mit Tier 4 final / Stufe IV-Motor



* Auf dem Foto kann optionale Ausrüstung gezeigt sein.

Nettleistung

SAE J1349 / 95 kW (127 PS) bei 2200 U/min

Bruttolistung

SAE J1995 / 97 kW (130 PS) bei 2200 U/min

Fahrgeschwindigkeit

5,6 km/h (3.5 mph) / 3,3 km/h (2.1 mph)

Betriebsgewicht

14050 kg (30,975 lb)



Die Bagger der HX-Serie sind Produkte im Sinne der Initiative, Kreativität und der starken Dynamik von HCE. Die Ingenieure von HCE gehören zu den besten ihrer Branche. Unermüdlich haben sie an der Entwicklung eines "Null-Fehler"-Produkt gearbeitet. Die neue HX-Serie ist das Ergebnis gründlicher Untersuchungen dessen, was in der Praxis gebraucht und gewünscht wird. Harte Einsatztests und strenge Qualitätsprüfungen bescheinigen den Maschinen optimale Kraftstoffeffizienz und Leistungsvermögen auf hohem Niveau.



- 1. Raupenbagger
- 2. Radbagger
- 3. Radlader

* Auf dem Foto kann optionale Ausrüstung gezeigt sein.

CHEF IM RING

Die HX-Serie übertrifft Kundenerwartungen!
Die HX-Serie von HHI setzt Maßstäbe.

HX140LC



EFFIZIENTER, STÄRKER

- ÖKO-Anzeige
- IPC (Intelligent Power Control)
- Neue variable Leistungssteuerung
- Volumenstromregelung für Anbaugeräte (Option)
- Neues Kühlsystem mit höherem Luftdurchsatz
- Großer Lufteinlass mit Gitterabdeckung
- Zykluszeitverbesserung



ZUVERLÄSSIGER, ROBUSTE

- Verschleißfeste Bolzen, Buchsen und Polymerscheiben
- Strapazierfähiges Kühlmodul
- Robuste, langlebige Konstruktion von Ober- und Unterwagen und Anbaugeräten
- Hochwertige (hochdruckfeste) Schläuche



INFOTAINMENT-KABINE

- Intelligentes Kontrollsystem
- Haptische Steuerung
- Wi-Fi Direct mit Smartphone (Miracast)
- Proportionale Zusatzhydraulik
- Neues Audiosystem
- Neue Klimaanlage



MODERNER KOMFORT, EINFACH UND SICHER

- Kameragestützte virtuelle Draufsicht incl. Bewegobjektüberwachung (AAVM + MOD) (Option)
- Rechte Seitenkamera (Option) **NEU**
- Einfacher Zugang zu DEF/AdBlue®-Versorgung
- Hi MATE (Maschinenmanagementsystem)
- Schwenksperre (Option)
- Feinsteuerung Schwenken (Option)



* Auf dem Foto kann optionale Ausrüstung gezeigt sein.



* Auf dem Foto kann optionale Ausrüstung gezeigt sein.

Kraftstoffverbrauchsinformation



EFFIZIENTER, STÄRKER

Kraftstoffeffizientes Hochleistungsaggregat

Die HX-Serie verfügt über einen umweltfreundlichen Motor, der sich durch sowohl beste Kraftstoffeffizienz als auch hohe Abgabeleistung auszeichnet. Das Aggregat hat seine herausragende Leistungsfähigkeit in anspruchsvollen Tests auf verschiedenen Baustellen unter Beweis gestellt und wird keinen Kundenwunsch offen lassen.



ÖKO-Anzeige

Die ÖKO-Anzeige unterstützt den wirtschaftlichen Maschinenbetrieb. Die farbigen Anzeigen weisen Motordrehmoment und Energieeffizienz aus. Genauso sieht der Bediener den durchschnittlichen und den Gesamtkraftstoffverbrauch. Der Kraftstoffverbrauch pro Stunde oder Tag ist über ein Detailmenü aufrufbar.



IPC (Intelligent Power Control)

Die intelligente Power steuerung IPC steuert die Pumpe bedarfsabhängig. Der Modus kann über das Display aktiviert oder deaktiviert werden. Im Modus "Aushub" lässt sich der Pumpenförderstrom kraftstoffsparend und einfach mit einem Hebel regulieren.

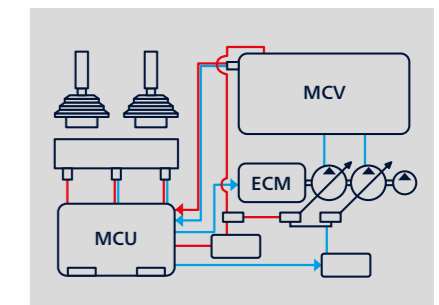

Neue variable Leistungssteuerung

Eingangs- und Ausgangssignale der Arbeitseinrichtung sind bei der HX-Serie auf einem Minimum gehalten – zugunsten niedriger Verbrauchswerte. Drei Leistungsmodi gewährleisten höchste Effizienz unter allen Einsatzanforderungen.

- * P-Modus (Power): maximale Geschwindigkeit und Kraft für schwere Arbeiten
- * S-Modus (Standard): optimale Leistung und Kraftstoffeffizienz für allgemeine Arbeiten
- * E-Modus (Economy): optimale Steuerung für leichte Arbeiten.



Volumenstromregelung für Anbaugeräte (Option)

Zur Optimierung des Pumpenförderstroms werden bei der HX-Serie zwei Pumpen unabhängig gesteuert. Die Funktion ermöglicht es, die effektive Förderleistung (für zehn verschiedene Hydraulikhämmer und zehn Abbruchscheren) exakt auf das jeweilige Anbaugerät und die Arbeitsbedingungen abzustimmen.



Neues Kühlsystem mit höherem Luftdurchsatz

Das Kühlmodul der HX-Serie verbessert durch einen dreistufigen Schichtaufbau den Lufteintrag und die Wärmeableitung, liefert somit eine ausgezeichnete Kühlleistung und ist leicht zu reinigen.



Großer Lufteinlass mit Gitterabdeckung

Das vergrößerte Luftloch in der luftlassenseitigen Abdeckung verfügt über ein feinmaschiges Gitter, das Fremdstoffe aus dem System hält und so die Lebensdauer verlängert.



Zykluszeitverbesserung

Die HX-Serie bietet höhere Produktivität auf der Baustelle durch schnellere Arbeitsspiele: Beim Lkw-Beladen sind die Maschinen 6 %, beim Einebnen 2% schneller als die 9er-Serie.

ZUVERLÄSSIGER, ROBUSTER

Neues Außendesign für Robustheit und Sicherheit

Der wahre Wert der HX-Serie liegt in ihrer Langlebigkeit. Die robuste Rahmenstruktur sowie die Anbaugeräte zeigen den wahren Wert der HX-Serie unter rauen Bedingungen und versprechen höhere Produktivität.

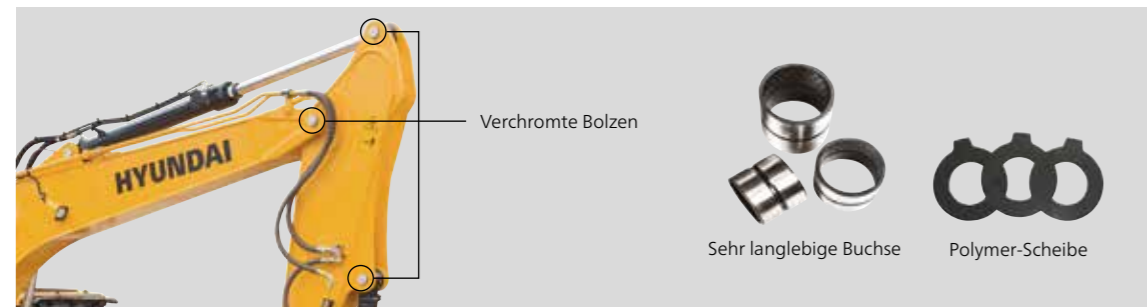

Verschleißfeste Bolzen, Buchsen und Polymerscheiben

Die Verbindungsteile zwischen Ausrüstung und Anbaugeräten sind bei der HX-Serie reibungsärmer geworden. Die eingesetzten Bolzen, Buchsen und Polymerscheiben sind verschleißfest ausgeführt und sorgen für passgenaue Schnittstellen mit ausgezeichneten, dauerbeständigen Gleit- und Gelenkeigenschaften.



Strapazierfähiges Kühlmodul

Die HX-Serie verfügt über ein Kühlmodul, das seine Leistungsfähigkeit und Strapazierfähigkeit in härtesten Tests unter Beweis gestellt hat.



Robuste, langlebige Konstruktion von Ober- und Unterwagen und Anbaugeräten

Oberwagen, Unterwagen und Anbaugeräte der HX-Serie erfüllen höhere Ansprüche an die strukturelle Langzeitstabilität als sie auf der Baustelle gestellt werden. Das belegen zahlreiche Tests, unter Einsatzbedingungen und in virtuellen Simulationen. Die Verschleißfestigkeit des Löffels wurde durch den Einsatz eines neuen Materials verbessert.



* Auf dem Foto kann optionale Ausrüstung gezeigt sein.



Hochwertige (hochdruckfeste) Schläuche

In der HX-Serie sind Hochdruckschläuche mit verbesserter Hitze- und Druckbeständigkeit eingesetzt, auch dies ein Beitrag zur Langlebigkeit der Ausrüstung.



* Auf dem Foto kann optionale Ausrüstung gezeigt sein.



Neue Klimaanlage an der Vorderseite

Die Belüftung ist so ausgelegt, dass sowohl warme als auch kalte Luft zum Gesicht des Fahrers geleitet werden kann. Diese Luftzirkulation im Innenraum schafft eine saubere und angenehme Atmosphäre für den Fahrer.

INFOTAINMENT-KABINE

Verbesserte Instrumententafel zur leichteren Überwachung

Zahlreiche elektronische Funktionen sind an einer für den Fahrer bequem erreichbaren Stelle angeordnet, sodass effizienteres Arbeiten möglich wird. Das hochentwickelte Infotainment-System, ein Produkt der intensiven Entwicklungsarbeit im Bereich der Informationstechnologie durch HCE, sorgt für Produktivität und gleichzeitig für Arbeitskomfort! Bei der Konzeption der HX-Serie stand der Fahrer stets im Mittelpunkt.



Intelligentes Kontrollsystem

Das 8-Zoll-Display in Kapazitivtechnik (ähnlich einem Smartphone-Display) der HX-Serie ist 15 % größer als beim Vormodell und leicht ablesbar. Mit den Displayschaltern lässt sich der Harnstoffvorrat genauso leicht wie die Außentemperatur prüfen. Bedien- und Anzeigeelemente für Audio-AUX, Klimaanlage, Heizung und Neigungssensor tragen zum Komfort des Bedieners bei.



Haptische Steuerung

Mit dem haptischen Multifunktionsknopf lassen sich mühelos und bequem Gas, Klimaanlage und Kombiinstrument bedienen. Sollte der haptische Schalterknopf ausfallen, wird im Kombiinstrument ein Notmodus aktiviert, der die Funktionen ausfallsicher macht.



Neues Audiosystem

Mit Radiogerät und USB-gestütztem MP3-Player, und zusätzlich mit integrierter Bluetooth-Freisprecheinrichtung und eingebautem Mikrofon, sodass während der Arbeit und Fahrt das Telefon bedient werden kann. Das Radiogerät wurde von hinten nach rechts verlegt und ist damit besser erreichbar.

Wi-Fi Direct mit Smartphone (Miracast)

Das Miracast-System nutzt die WLAN-Funktion des Smartphones und ermöglicht es dem Bediener einfach und komfortabel, diverse Funktionen seines Smartphones, wie Navigation, Webbrowser, Video und Musik, auf den großen Bildschirm zu legen (derzeit für Android-Mobiltelefone)



Proportionale Zusatzhydraulik

- Option: Proportional wirkender Schalter für feinfühligere Geschwindigkeitssteuerung
- Höherer Komfort für den Bediener

MODERNER KOMFORT, EINFACH UND SICHER

Neue Kabine für verbesserten Komfort

Leise, vibrationsarm und ergonomisch gestaltet – so erlebt sich das Kabineninnere komfortabel und angenehm! Ein besonderes Augenmerk bei der HX-Serie sind die Sicherheit und der Komfort des Bedieners: So ist im Sinne optimaler Arbeitsbedingungen auch die schnelle und sichere Inspektion der Ausrüstung jederzeit und an jedem Ort gewährleistet.



Kameragestützte virtuelle Draufsicht incl. Bewegobjektüberwachung (AAVM + MOD)

Die HX-Serie verfügt über ein Rundumsicht-Videokamerasystem nach dem neuesten Stand der Technik. Das System ermöglicht den unfallverhütenden Blick in alle Richtungen. Der Bediener erhält Sicht nach vorn und hinten, rechts und links der Maschine.

* AAVM (Advanced Around View Monitoring): Der erweiterte Rundumsichtmonitor bietet neun Ansichten einschließlich 3D-Vogelperspektive und 2D/4KA-Sicht.
* IMOD (Intelligent Moving Object Detection): Die intelligente Bewegobjekterkennung erfasst Personen und Gegenstände, die sich innerhalb des Erfassungsbereichs (5 m) bewegen.

Rechte Seitenkamera (Option)

HiMATE

Bequem, einfach und wertvoll

Hi MATE, das neu entwickelte System zur Fernverwaltung von Hyundai mit GPS-Satellitentechnologie, bietet den Kunden den besten Service und Produktsupport. Mit Hi MATE hat der Nutzer aus der Ferne per Knopfdruck Zugriff auf Informationen wie Maschinenleistung, Diagnosedaten und Maschinenstandort.

Vorteile:



Steigerung der Produktivität

Sie können hiermit Maschinen effizienter betreiben. Sie können den Unterschied zwischen den Gesamt-Motorbetriebsstunden und den tatsächlichen Arbeitsstunden überprüfen. Stellen Sie fest, wie produktiv Ihre Maschinen sind, und planen Sie ggf. erforderliche Kosteneinsparungslösungen. Hi MATE bietet Betriebsinformationen wie Betriebs-/Leerlaufstunden, Kraftstoffverbrauch und Rate.



Bequeme und einfache Überwachung

Sie brauchen nicht viel zu tun, um Ihre Maschinen zu überwachen. Melden Sie sich einfach bei der Hi MATE-Website oder der mobilen App an. Mithilfe von Hi MATE können Sie Ihre Maschinen immer und überall beobachten.



Sicherheit

Schützen Sie Ihre Maschinen mit Hi MATE vor Diebstahl oder unbefugter Nutzung. Wenn die Maschine den "Geo-Fence"-Bereich verlässt, erhalten Sie Warnmeldungen.



* Auf dem Foto kann optionale Ausrüstung gezeigt sein.

Einfacher Zugang zu DEF/AdBlue®-Versorgung

Der DEF/AdBlue®-Behälter befindet sich im Werkzeugkasten und der Befüllanschluss ist leicht zugänglich vom Behälter abgesetzt angeordnet. Eine rote Warnleuchte signalisiert die Füllstoppgrenze. Das DEF/AdBlue®-Zuführmodul befindet sich zur einfachen Wartung und zum Filterwechsel neben dem Kraftstofftank.

Schwenkbegrenzung (Option)

Die Schwenkbegrenzung erhöht die Stabilität der Maschine, wo die Schwenkbewegung automatisch begrenzt werden soll – Arbeitsgeschwindigkeit und Produktivität gewinnen hierdurch.

Feinsteuerung Schwenken (Option)

Diese Option ermöglicht bei Bedarf eine komfortable Feinsteuerung des Schwenkvorgangs.

TECHNISCHE DATEN

MOTOR	
Hersteller / Modell	Cummins QSF 3.8
Typ	4-Takt-Dieselmotor mit Turbolader und Ladeluftkühlung
Nennleistung am Schwungrad	SAE J1995 (brutto) 97 kW (130 PS) bei 2200 U/min
	SAE J1349 (netto) 95 kW (127 PS) bei 2200 U/min
Schwungrad	DIN 6271/1 (brutto) 97 kW (132 PS) bei 2200 U/min
	DIN 6271/1 (netto) 95 kW (129 PS) bei 2200 U/min
Höchstdrehmoment	50 kgf·m (360 lbf·ft) bei 1600 U/min
Bohrung x Hub	102 x 115 mm (4.02" x 4.53")
Hubraum	3800 cc (229 cu in)
Batterien	2 x 12 V x 100 Ah
Anlasser	24 V - 4,8 kW
Generator	28 V - 70 A

HYDRAULIKSYSTEM	
HAUPTPUMPE	
Typ	Verstellbare Axialkolbenpumpen in Tandemausführung
Maximaler Durchfluss	2 x 126,8 l/min
Hilfspumpe für Vorsteuerkreis	Zahnradpumpe

Quererfassendes und kraftstoffsparendes Pumpensystem

HYDRAULIKMOTOREN	
Fahren	Axialkolbenmotor mit zwei Geschwindigkeiten mit Bremsventil und Parkbremse
Schwenken	Axialkolbenmotor mit automatischer Bremse

ÜBERDRUCKVENTILEINSTELLUNG	
Anbaugerätkreise	350 kgf/cm ² (4980 psi)
Fahren	350 kgf/cm ² (4980 psi)
Leistungsstufe (Ausleger, Löffelstiel, Löffel)	380 kgf/cm ² (5400 psi)
Schwenkkreis	285 kgf/cm ² (4054 psi)
Vorsteuerkreis	40 kgf/cm ² (570 psi)
Serviceventil	Installiert

HYDRAULIKZYLINDER	
Zylinder: Bohrung x Hub	Ausleger: ø 105 x 1075 mm Löffelstiel: ø 115 x 1138 mm Tiefloffel: ø 100 x 850 mm

ANTRIEBE UND BREMSEN	
Antriebsart	Vollhydrostatisch
Antriebsmotor	Axialkolbenmotor, mit Bremse integriert
Untersetzung	Planetenuntersetzungsgetriebe
Max. Zugkraft	12.000 kgf (26,455 lbf)
Max. Fahrgeschwindigkeit (Schnell-/Langsamgang)	5,6 km/h (3,5 mph) / 3,3 km/h (2,1 mph)
Steigfähigkeit	35° (70%)
Handbremse	Mehrscheibenausführung, nass

STEUERUNG	
Vorsteuerdruckunterstützte Joysticks und Pedale mit abnehmbarem Hebel für nahezu kraft- und ermüdungsfreie Bedienung.	
Vorsteuerung	Zwei Joysticks mit einem Sicherheitshebel (links): Schwenken und Löffelstiel (rechts): Ausleger und Tiefloffel (ISO)
Fahren und Lenken	Zwei Hebel mit Pedalen
Motordrossel	Elektrisch, als Drehregler ausgeführt

SCHWENKWERK	
Schwenkmotor	Axialkolbenmotor mit festem Schluckvolumen
Schwenkuntersetzung	Planetenraduntersetzung
Drehkransschmierung	Fettbad
Schwenkbremse	Mehrscheibenausführung, nass
Schwenkgeschwindigkeit	11,6 U/min

SERVICE-FÜLLMENGEN			
Nachfüllmenge	liter	US gal	UK gal
Kraftstofftank	270	71,3	59,4
Motorkühlmittel	27,5	7,3	6,0
Motoröl	12	3,2	2,6
Schwenkeinrichtung	3,5	0,9	0,76
Endantrieb (je)	2,3	0,60	0,50
Hydrauliksystem (einschl. Behälter)	210	55,5	46,2
Hydraulikölbehälter	124	32,8	27,3
DEF/AdBlue®	19	5	4,2

UNTERWAGEN	
Der X-Mittelrahmen ist eine vollverschweißte Konstruktion mit verstärkten Kastenrahmen für das Laufwerk. Der Unterwagen ist mit geschmierten Rollen, Leiträdern, Kettenspannern mit stoßdämpfenden Federn und Antriebsrädern sowie Raupenkettens mit 2- oder 3-Steg-Bodenplatten ausgerüstet.	
Mittelrahmen	X-Rahmen
Unterwagen	Fünfeckiges Kastenprofil
Kettenplatten pro Seite	46 EA
Stützrollen pro Seite	1 EA
Laufrollen pro Seite	7 EA
Kettenführungen pro Seite	1 EA

BETRIEBSGEWICHT (CIRCA)	
Betriebsgewicht, einschliesslich 4600 mm (15' 1") Ausleger; 2500 mm (8' 2") Löffelstiel; SAE gehäuft 0,58 m ³ (0,76 yd ³) Löffel gehäuft nach SAE, Schmiermittel, Kühlmittel, vollem Kraftstofftank, vollem Hydraulikölbehälter und aller Standardausrüstung.	

BETRIEBSGEWICHT				
Platten	Betriebsgewicht		Bodendruck	
Typ	Breite mm (in)	kg (lb)	kgf/cm ² (psi)	
Dreisteg	500 (20")	HX140L C	13840 (30,510)	0,43 (6,07)
		HX140LD C	14660 (32,320)	0,45 (6,43)
	600 (24")	HX140L C	14050 (30,975)	0,36 (5,13)
		HX140LD C	14870 (32,780)	0,38 (5,43)
	700 (28")	HX140L C	14260 (31,440)	0,31 (4,47)
		HX140LD C	15080 (33,245)	0,33 (4,72)
800 (32")	HX140HW C	16950 (37,370)	0,32 (4,58)	
	Doppelsteg 700 (28")	HX140HW C	16715 (36,850)	0,36 (5,16)

AUSWAHLHILFE BAGGERLÖFFEL UND SCHACHTKRAFT

LÖFFEL

Die Löffel sind im Stahlauführung, völlig Verschweisst und Zugfest.

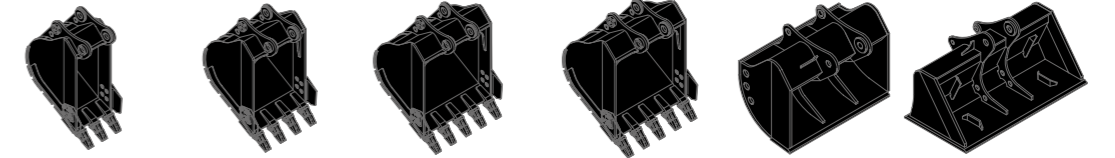

gehäuft nach SAE m ³ (yd ³)	0,23 (0,30)	0,40 (0,52)	0,52 (0,68)	0,65 (0,85)	◆ 0,45 (0,59)	◆ 0,55 (0,72)
--	-------------	-------------	-------------	-------------	---------------	---------------

Inhalt m ³ (yd ³)	Breite mm (in)	Gewicht kg (lb)	Empfehlung mm (ft.in)							
			4600 (15' 1") Ausleger			4100 (13' 5") Ausleger				
gehäuft nach SAE	gehäuft nach CECE	Ohne Seitenschneidkanten	Mit Seitenschneidkanten	1900 (6' 3") Löffelstiel	2100 (6' 11") Löffelstiel	2500 (8' 2") Löffelstiel	3000 (9' 10") Löffelstiel	1900 (6' 3") Löffelstiel	2100 (6' 11") Löffelstiel	
0,23 (0,30)	0,20 (0,26)	520 (20,5)	620 (24,4)	335 (740)	●	●	●	■	●	●
0,40 (0,52)	0,35 (0,46)	750 (29,5)	850 (33,5)	410 (900)	●	●	●	■	●	●
0,46 (0,60)	0,40 (0,52)	840 (33,1)	940 (37,0)	435 (960)	●	●	●	▲	●	●
0,52 (0,68)	0,45 (0,59)	915 (36,0)	1015 (40,0)	460 (1010)	●	●	●	-	●	●
0,58 (0,76)	0,50 (0,65)	1000 (39,4)	1100 (43,3)	480 (1060)	●	●	■	-	●	●
0,65 (0,85)	0,55 (0,72)	1105 (43,5)	1205 (47,4)	500 (1100)	■	■	▲	-	●	■
0,71 (0,93)	0,60 (0,78)	1190 (46,9)	1290 (50,8)	540 (1190)	▲	▲	-	-	■	▲
◆ 0,45 (0,59)	0,40 (0,52)	1520 (59,8)	-	410 (900)	●	●	■	-	●	●
◆ 0,55 (0,72)	0,45 (0,59)	1800 (70,9)	-	585 (1290)	■	■	▲	-	●	●

- ◆ Grubenlöffel
- ◆ Böschungslöffel

- : Für Material mit einer Dichte von maximal 2000 kg/m³ (3370 lb/yd³)
- : Für Material mit einer Dichte von maximal 1600 kg/m³ (2700 lb/yd³)
- ▲ : Für Material mit einer Dichte von maximal 1100 kg/m³ (1850 lb/yd³)

ANBAUGERÄT

Ausleger und Löffelstiel sind als verschweißtes, spannungsarmes Kastenprofil ausgeführt. Erhältlich: Ausleger in 4,1 m (13' 5"); 4,6 m (15' 1") und 2-teiliger Ausleger in 4,9 m (16' 9") und Löffelstiel in 1,9 m (6' 3"); 2,1 m (6' 11"); 2,5 m (8' 2") und 3,0 m (9' 1").

SCHACHTKRAFT							
Löffelstiel	Länge	mm (ft.in)	1900 (6' 3")	2100 (6' 11")	2500 (8' 2")	3000 (9' 10")	Anmerkungen:
			Gewicht	kg (lb)	kg (lb)	kg (lb)	
Tiefloffel Losbrechkraft	SAE	kN	87,3 [94,8]	87,3 [94,8]	87,3 [94,8]	87,3 [94,8]	[: Leistungsstufe
		kgf	8900 [9660]	8900 [9660]	8900 [9660]	8900 [9660]	
		lbf	19620 [21300]	19620 [21300]	19620 [21300]	19620 [21300]	
	ISO	kN	102 [110,8]	102 [110,8]	102 [110,8]	102 [110,8]	
		kgf	10400 [11290]	10400 [11290]	10400 [11290]	10400 [11290]	
		lbf	22930 [24890]	22930 [24890]	22930 [24890]	22930 [24890]	
Tiefloffelstiel Reißkraft	SAE	kN	76,5 [83,1]	73,6 [79,9]	62,8 [68,2]	55,9 [60,7]	
		kgf	7800 [8470]	7500 [8140]	6400 [6950]	5700 [6190]	
		lbf	17200 [18670]	16530 [17950]	14110 [15320]	12570 [13640]	
	ISO	kN	80,4 [87,3]	77,5 [84,1]	65,7 [71,4]	57,9 [62,8]	
		kgf	8200 [8900]	7900 [8580]	6700 [7270]	5900 [6410]	
		lbf	18080 [19630]	17420 [18910]	14770 [16040]	13010 [14120]	

Hinweis: Stielgewicht inklusive Löffelzylinder, Verbindungsstangen und Bolzen.

MASSE UND ARBEITSBEREICH

ABMESSUNGEN HX140L C

Ausleger 4,1 m (13' 5") & 4,6 m (15' 1") und Löffelstiel 1,9 m (6' 3"); 2,1 m (6' 11"); 2,5 m (8' 2") und 3,0 m (9' 10").

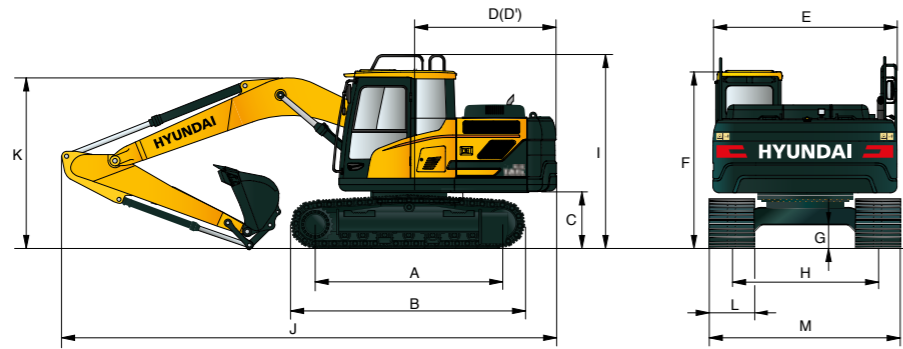

Einheit: mm (ft-in)

A	Aufstandslänge	3000 (9' 10")
B	Gesamtlänge der Raupe	3708 (12' 2")
C	Bodenfreiheit des Heckgegengewichts	940 (3' 1")
D	Heckschwenkradius	2330 (7' 7")
D'	Hecklänge	2330 (7' 7")
E	Gesamtbreite des Oberwagens	2475 (8' 1")
F	Gesamthöhe der Kabine	2860 (9' 5")
G	Mindest-Bodenfreiheit	440 (1' 5")
H	Spurweite	2000 (6' 7")
I	Gesamthöhe des Schutzgeländers	3100 (10' 2")

Auslegerlänge	4600 (15' 1")				4100 (13' 5")	
Löffelstiellänge	1900 (6' 3")	2100 (6' 11")	2500 (8' 2")	3000 (9' 10")	1900 (6' 3")	2100 (6' 11")
J Gesamtlänge	7820 (25' 7")	7850 (25' 8")	7820 (25' 7")	7790 (25' 6")	7320 (24' 0")	7350 (24' 1")
K Gesamthöhe des Auslegers	2650 (8' 7")	2760 (9' 0")	2780 (9' 1")	3110 (10' 2")	2600 (8' 5")	2790 (9' 2")
L Breite der Bodenplatten	500 (20")		600 (24")		700 (28")	
M Gesamtbreite	2500 (8' 2")		2600 (8' 6")		2700 (8' 10")	

ARBEITSBEREICH HX140L C

Einheit: mm (ft-in)

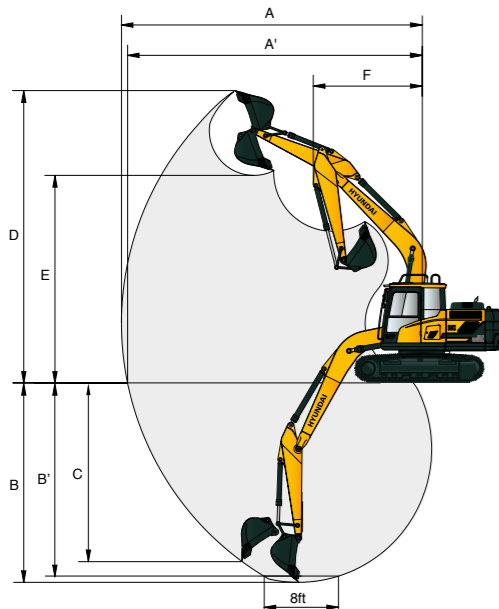

Auslegerlänge	4600 (15' 1")				4100 (13' 5")	
Löffelstiellänge	1900 (6' 3")	2100 (6' 11")	2500 (8' 2")	3000 (9' 10")	1900 (6' 3")	2100 (6' 11")
A Max. Schachtweite	7750 (25' 5")	7920 (25' 11")	8330 (27' 4")	8790 (28' 10")	7260 (23' 10")	7420 (24' 4")
A' Max. Schachtweite am Boden	7600 (24' 11")	7770 (25' 6")	8180 (26' 10")	8650 (28' 4")	7090 (23' 3")	7260 (23' 10")
B Max. Schachttiefe	4950 (16' 2")	5150 (16' 10")	5550 (18' 3")	6050 (19' 10")	4540 (14' 11")	4740 (15' 7")
B' Max. Schachttiefe (auf ca. 2,40 m)	4680 (15' 4")	4900 (16' 1")	5340 (17' 6")	5870 (19' 3")	4280 (14' 1")	4490 (14' 9")
C Max. vertikale Abstehtiefe	4650 (15' 3")	4900 (16' 1")	5330 (17' 6")	5850 (19' 2")	4240 (13' 11")	4350 (14' 3")
D Max. Einstechhöhe	8100 (26' 7")	8180 (26' 10")	8500 (27' 11")	8780 (28' 10")	7700 (25' 3")	7770 (25' 6")
E Max. Ladehöhe	5670 (18' 7")	5750 (18' 10")	6060 (19' 11")	6330 (20' 9")	5260 (17' 3")	5340 (17' 6")
F Min. Frontschwenkradius	2630 (8' 8")	2670 (8' 9")	2650 (8' 8")	2680 (8' 10")	2350 (7' 9")	2460 (8' 1")

MASSE UND ARBEITSBEREICH

ABMESSUNGEN HX140LD C

Ausleger 4,1 m (13' 5") & 4,6 m (15' 1") und Löffelstiel 1,9 m (6' 3"); 2,1 m (6' 11"); 2,5 m (8' 2") und 3,0 m (9' 10").

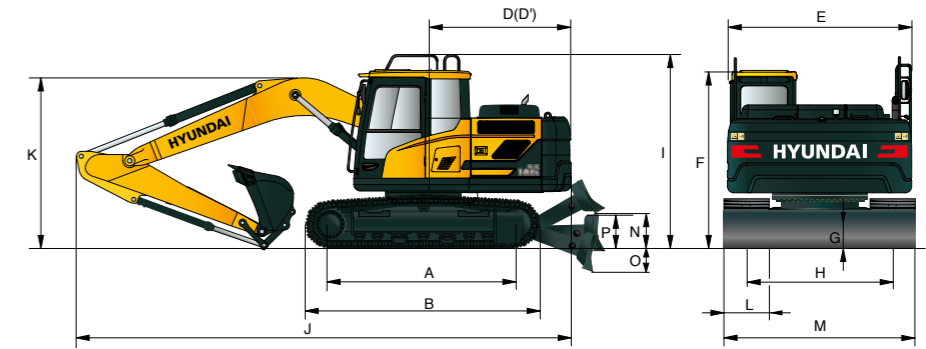

Einheit: mm (ft-in)

A	Aufstandslänge	3000 (9' 10")
B	Gesamtlänge der Raupe	3708 (12' 2")
C	Bodenfreiheit des Heckgegengewichts	940 (3' 1")
D	Heckschwenkradius	2330 (7' 7")
D'	Hecklänge	2330 (7' 7")
E	Gesamtbreite des Oberwagens	2475 (8' 1")
F	Gesamthöhe der Kabine	2960 (9' 9")
G	Mindest-Bodenfreiheit	440 (1' 5")
H	Spurweite	2000 (6' 7")
I	Gesamthöhe des Schutzgeländers	3180 (10' 5")
N	Bodenfreiheit mit gehobenem Planierschild	560 (1' 10")
O	Tiefe mit abgesenktem Planierschild	500 (1' 8")
P	Höhe des Planierschildes	575 (1' 11")

Auslegerlänge	4600 (15' 1")				4100 (13' 5")	
Löffelstiellänge	1900 (6' 3")	2100 (6' 11")	2500 (8' 2")	3000 (9' 10")	1900 (6' 3")	2100 (6' 11")
J Gesamtlänge	8130 (26' 7")	8160 (26' 7")	8130 (26' 7")	8100 (26' 6")	7630 (25' 0")	7350 (24' 1")
K Gesamthöhe des Auslegers	2650 (8' 7")	2760 (9' 0")	2780 (9' 1")	3110 (10' 2")	2600 (8' 5")	2790 (9' 2")
L Breite der Bodenplatten	500 (20")		600 (24")		700 (28")	
M Gesamtbreite	2500 (8' 2")		2600 (8' 6")		2700 (8' 10")	

ARBEITSBEREICH HX140LD C

Einheit: mm (ft-in)

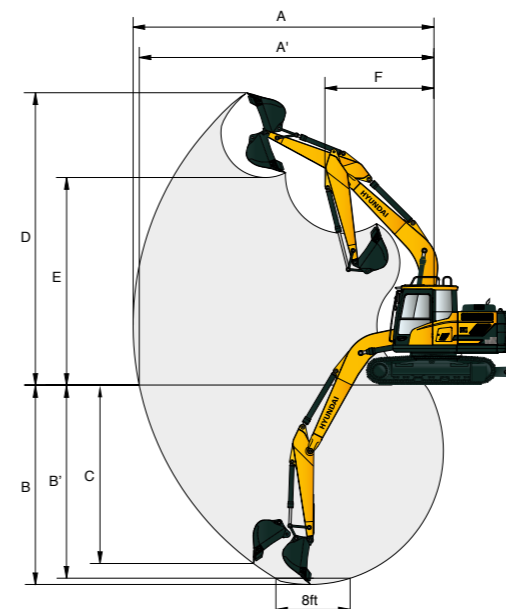

Auslegerlänge	4600 (15' 1")				4100 (13' 5")	
Löffelstiellänge	1900 (6' 3")	2100 (6' 11")	2500 (8' 2")	3000 (9' 10")	1900 (6' 3")	2100 (6' 11")
A Max. Schachtweite	7750 (25' 5")	7920 (25' 11")	8330 (27' 4")	8790 (28' 10")	7260 (23' 10")	7420 (24' 4")
A' Max. Schachtweite am Boden	7600 (24' 11")	7770 (25' 6")	8180 (26' 10")	8650 (28' 4")	7090 (23' 3")	7260 (23' 10")
B Max. Schachttiefe	4950 (16' 2")	5150 (16' 10")	5550 (18' 3")	6050 (19' 10")	4540 (14' 11")	4740 (15' 7")
B' Max. Schachttiefe (auf ca. 2,40 m)	4680 (15' 4")	4900 (16' 1")	5340 (17' 6")	5870 (19' 3")	4280 (14' 1")	4490 (14' 9")
C Max. vertikale Abstehtiefe	4650 (15' 3")	4900 (16' 1")	5330 (17' 6")	5850 (19' 2")	4240 (13' 11")	4350 (14' 3")
D Max. Einstechhöhe	8100 (26' 7")	8180 (26' 10")	8500 (27' 11")	8780 (28' 10")	7700 (25' 3")	7770 (25' 6")
E Max. Ladehöhe	5670 (18' 7")	5750 (18' 10")	6060 (19' 11")	6330 (20' 9")	5260 (17' 3")	5340 (17' 6")
F Min. Frontschwenkradius	2630 (8' 8")	2670 (8' 9")	2650 (8' 8")	2680 (8' 10")	2350 (7' 9")	2460 (8' 1")

MASSE UND ARBEITSBEREICH

ABMESSUNGEN HX140HW C

Ausleger 4,1 m (13' 5") & 4,6 m (15' 1") und Löffelstiel 1,9 m (6' 3"); 2,1 m (6' 11"); 2,5 m (8' 2") und 3,0 m (9' 10").

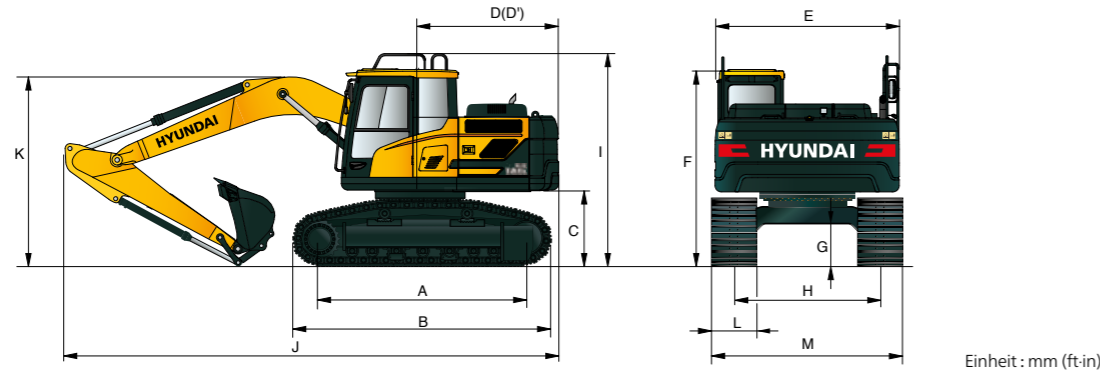

Einheit: mm (ft-in)

A	Aufstandslänge	3000 (9' 10")
B	Gesamtlänge der Raupe	3740 (12' 3")
C	Bodenfreiheit des Heckgegengewichts	1200 (3' 11")
D	Heckschwenkradius	2330 (7' 7")
D'	Hecklänge	2330 (7' 7")
E	Gesamtbreite des Oberwagens	2475 (8' 1")
F	Gesamthöhe der Kabine	3220 (10' 7")
G	Mindest-Bodenfreiheit	600 (1' 12")
H	Spurweite	2040 (6' 8")
I	Gesamthöhe des Schutzgeländers	3100 (10' 2")

Auslegerlänge	4600 (15' 1")				4100 (13' 5")	
Löffelstiellänge	1900 (6' 3")	2100 (6' 11")	2500 (8' 2")	3000 (9' 10")	1900 (6' 3")	2100 (6' 11")
J Gesamtlänge	7820 (25' 7")	7850 (25' 8")	7820 (25' 7")	7790 (25' 6")	7320 (24' 0")	7350 (24' 1")
K Gesamthöhe des Auslegers	2650 (8' 7")	2760 (9' 0")	2780 (9' 1")	3110 (10' 2")	2600 (8' 5")	2790 (9' 2")
L Breite der Bodenplatten	700 (28")	800 (32")			900 (36")	
M Gesamtbreite	2740 (8' 11")	2840 (9' 3")			3000 (9' 10")	

MASSE UND ARBEITSBEREICH

ABMESSUNGEN HX140L C 2-TEILIGER AUSLEGER

2-teiliger Ausleger 4,9 m (16' 1") und Löffelstiel 1,9 m (6' 3"); 2,1 m (6' 11"); 2,5 m (8' 2") und 3,0 m (9' 10").

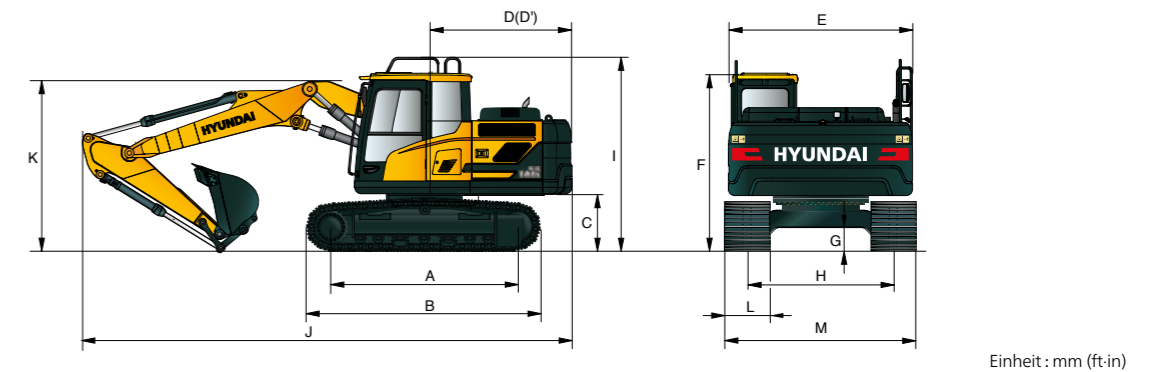

Einheit: mm (ft-in)

A	Aufstandslänge	3000 (9' 10")
B	Gesamtlänge der Raupe	3750 (12' 4")
C	Bodenfreiheit des Heckgegengewichts	940 (3' 1")
D	Heckschwenkradius	2330 (7' 7")
D'	Hecklänge	2330 (7' 7")
E	Gesamtbreite des Oberwagens	2500 (8' 2")
F	Gesamthöhe der Kabine	2870 (9' 4")
G	Mindest-Bodenfreiheit	440 (1' 5")
H	Spurweite	2000 (6' 7")
I	Gesamthöhe des Schutzgeländers	3100 (10' 2")

Auslegerlänge	4900 (16' 1") 2-teiliger Ausleger		
Löffelstiellänge	1900 (6' 3")	2100 (6' 11")	2500 (8' 2")
J Gesamtlänge	8160 (26' 8")	8170 (26' 8")	8150 (26' 8")
K Gesamthöhe des Auslegers	2830 (9' 3")	2940 (9' 6")	2960 (9' 7")
L Breite der Bodenplatten	500 (20")	600 (24")	700 (28")
M Gesamtbreite	2500 (8' 2")	2600 (8' 6")	2700 (8' 10")

ARBEITSBEREICH HX140HW C

Einheit: mm (ft-in)

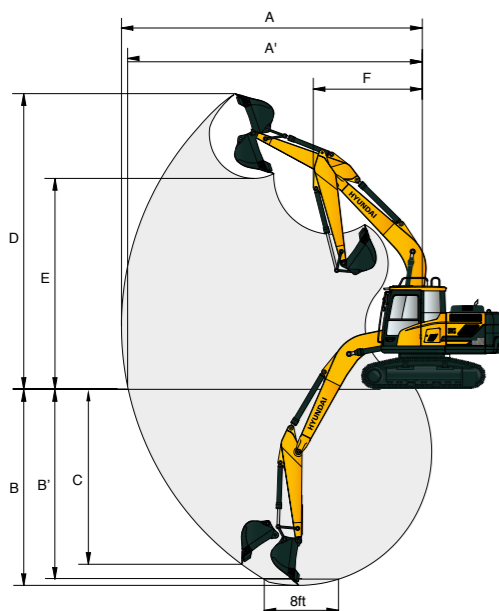

Auslegerlänge	4600 (15' 1")				4100 (13' 5")	
Löffelstiellänge	1900 (6' 3")	2100 (6' 11")	2500 (8' 2")	3000 (9' 10")	1900 (6' 3")	2100 (6' 11")
A Max. Schachtweite	7750 (25' 5")	7920 (25' 11")	8330 (27' 4")	8790 (28' 10")	7260 (23' 10")	7420 (24' 4")
A' Max. Schachtweite am Boden	7540 (24' 9")	7710 (25' 4")	8110 (26' 7")	8580 (28' 2")	7020 (23' 10")	7200 (23' 7")
B Max. Schachttiefe	4690 (15' 5")	4890 (16' 1")	5290 (17' 4")	5790 (19' 0")	4280 (14' 1")	4480 (14' 8")
B' Max. Schachttiefe (auf ca. 2,40 m)	4420 (14' 6")	4640 (15' 3")	5080 (16' 8")	5610 (18' 5")	4020 (13' 2")	4230 (13' 11")
C Max. vertikale Abstehtiefe	4390 (14' 5")	4640 (15' 3")	5070 (16' 8")	5590 (18' 4")	3980 (13' 1")	4090 (13' 5")
D Max. Einstechhöhe	8360 (27' 5")	8440 (27' 8")	8760 (28' 9")	9040 (29' 7")	7960 (26' 1")	8030 (26' 4")
E Max. Ladehöhe	5930 (19' 5")	6010 (19' 8")	6320 (20' 9")	6590 (21' 7")	5520 (18' 1")	5600 (18' 4")
F Min. Frontschwenkradius	2630 (8' 8")	2670 (8' 9")	2650 (8' 8")	2680 (8' 10")	2350 (7' 9")	2460 (8' 1")

ARBEITSBEREICH HX140L C 2-TEILIGER AUSLEGER

Einheit: mm (ft-in)

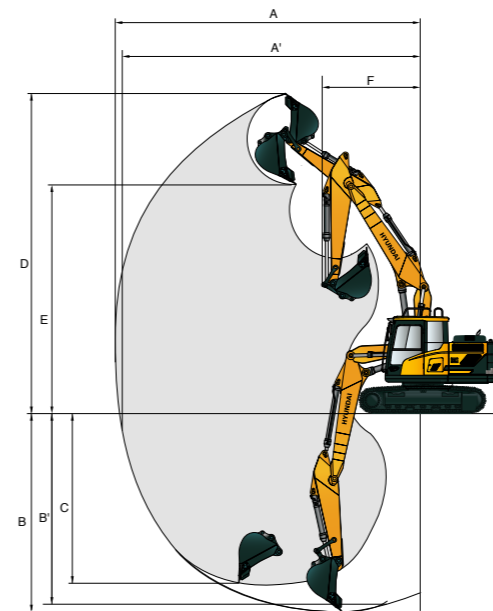











Auslegerlänge	4900 (16' 1") 2-teiliger Ausleger		
Löffelstiellänge	1900 (6' 3")	2100 (6' 11")	2500 (8' 2")
A Max. Schachtweite	8140 (26' 8")	8320 (27' 4")	8720 (28' 7")
A' Max. Schachtweite am Boden	8000 (26' 3")	8180 (26' 10")	8590 (28' 2")
B Max. Schachttiefe	5110 (16' 9")	5310 (17' 5")	5710 (18' 9")
B' Max. Schachttiefe (auf ca. 2,40 m)	5000 (16' 5")	5190 (17' 0")	5610 (18' 5")
C Max. vertikale Abstehtiefe	4490 (14' 9")	4660 (15' 3")	5120 (16' 10")
D Max. Einstechhöhe	8810 (28' 11")	8890 (29' 2")	9270 (30' 5")
E Max. Ladehöhe	6330 (20' 9")	6410 (21' 0")	6780 (22' 3")
F Min. Frontschwenkradius	2670 (8' 9")	2830 (9' 3")	2690 (8' 10")

HUBVERMÖGEN











 Lastradius Frontauslage  Lastradius Seitenauslage bzw. 360 Grad

HX140L C











Ausleger : 4,1 m (13' 5") / Löffelstiel : 1,9 m (6' 3") / Bodenplatten : 600 mm (24") 3-Stege-Bodenplatte / Heckgegengewicht : 2000 kg / Ohne Planierschild

Lasthöhe m (ft)	Lastradius								Max. Reichweite		
	1,5 m (4.9 ft)		3,0 m (9.8 ft)		4,5 m (14.8 ft)		6,0 m (19.7 ft)		Volumen	Reichweite	
											
6,0 m (19.7 ft)	kg								*3500	*3500	4,01
	lb								*7720	*7720	(13.2)
4,5 m (14.8 ft)	kg			*4620	4100				*3070	*3070	5,24
	lb			*10190	9040				*6770	*6770	(17.2)
3,0 m (9.8 ft)	kg		*7190	*7190	*5320	3960			*3020	2670	5,83
	lb		*15850	*15850	*11730	8730			*6660	5890	(19.1)
1,5 m (4.9 ft)	kg		*9910	6870	5790	3780	*3230	2510	*3220	2500	6,00
	lb		*21850	15150	12760	8330	*7120	5530	*7100	5510	(19.7)
Boden- niveau	kg		*10670	6660	5650	3660			*3720	2600	5,78
	lb		*23520	14680	12460	8070			*8200	5730	(19.0)
-1,5 m (-4.9 ft)	kg	*8110	*8110	*9920	6680	5640	3640		4670	3080	5,11
	lb	*17880	*17880	*21870	14730	12430	8020		10300	6790	(16.7)
-3,0 m (-9.8 ft)	kg			*7310	6860				*5520	4900	3,75
	lb			*16120	15120				*12170	10800	(12.3)

Ausleger : 4,1 m (13' 5") / Löffelstiel : 1,9 m (6' 3") / Bodenplatten : 600 mm (24") 3-Stege-Bodenplatte / Heckgegengewicht : 2000 kg / Planierschild abgesenkt

Lasthöhe m (ft)	Lastradius								Max. Reichweite		
	1,5 m (4.9 ft)		3,0 m (9.8 ft)		4,5 m (14.8 ft)		6,0 m (19.7 ft)		Volumen	Reichweite	
											
6,0 m (19.7 ft)	kg								*3500	*3500	4,01
	lb								*7720	*7720	(13.2)
4,5 m (14.8 ft)	kg			*4620	*4620				*3070	*3070	5,24
	lb			*10190	*10190				*6770	*6770	(17.2)
3,0 m (9.8 ft)	kg		*7190	*7190	*5320	4510			*3020	*3020	5,83
	lb		*15850	*15850	*11730	9940			*6660	*6660	(19.1)
1,5 m (4.9 ft)	kg		*9910	7970	*6300	4320	*3230	2860	*3220	2860	6,00
	lb		*21850	17570	*13890	9520	*7120	6310	*7100	6310	(19.7)
Boden- niveau	kg		*10670	7760	*6870	4200			*3720	2970	5,78
	lb		*23520	17110	*15150	9260			*8200	6550	(19.0)
-1,5 m (-4.9 ft)	kg	*8110	*8110	*9920	7780	*6560	4180		*4950	3530	5,11
	lb	*17880	*17880	*21870	17150	*14460	9220		*10910	7780	(16.7)
-3,0 m (-9.8 ft)	kg			*7310	*7310				*5520	*5520	3,75
	lb			*16120	*16120				*12170	*12170	(12.3)

Ausleger : 4,1 m (13' 5") / Löffelstiel : 1,9 m (6' 3") / Bodenplatten : 600 mm (24") 3-Stege-Bodenplatte / Heckgegengewicht : 2000 kg / Planierschild gehoben

Lasthöhe m (ft)	Lastradius								Max. Reichweite		
	1,5 m (4.9 ft)		3,0 m (9.8 ft)		4,5 m (14.8 ft)		6,0 m (19.7 ft)		Volumen	Reichweite	
											
6,0 m (19.7 ft)	kg								*3500	*3500	4,01
	lb								*7720	*7720	(13.2)
4,5 m (14.8 ft)	kg			*4620	4310				*3070	*3070	5,24
	lb			*10190	9500				*6770	*6770	(17.2)
3,0 m (9.8 ft)	kg		*7190	*7190	*5320	4170			*3020	2810	5,83
	lb		*15850	*15850	*11730	9190			*6660	6190	(19.1)
1,5 m (4.9 ft)	kg		*9910	7230	5790	3980	*3230	2650	*3220	2650	6,00
	lb		*21850	15940	12760	8770	*7120	5840	*7100	5840	(19.7)
Boden- niveau	kg		*10670	7030	5650	3860			*3720	2750	5,78
	lb		*23520	15500	12460	8510			*8200	6060	(19.0)
-1,5 m (-4.9 ft)	kg	*8110	*8110	*9920	7040	5630	3850		4670	3260	5,11
	lb	*17880	*17880	*21870	15520	12410	8490		10300	7190	(16.7)
-3,0 m (-9.8 ft)	kg			*7310	7230				*5520	5160	3,75
	lb			*16120	15940				*12170	11380	(12.3)

- Die Hublast richtet sich nach der Definition in SAE J1097 und ISO 10567.
- Die Hublast der Serie HX darf auf festem, ebenem Untergrund maximal 75 % der Kipplast der Maschine bzw. 87 % der gesamten hydraulischen Hubkraft betragen.











- Der Lasthaken befindet sich an der Rückseite des Tieflöffels.
- (*) gibt die Lastbegrenzung durch die hydraulische Hubkraft an.

HUBVERMÖGEN











 Lastradius Frontauslage  Lastradius Seitenauslage bzw. 360 Grad

HX140L C











Ausleger : 4,1 m (13' 5") / Löffelstiel : 2,1 m (6' 11") / Bodenplatten : 600 mm (24") 3-Stege-Bodenplatte / Heckgegengewicht : 2000 kg / Ohne Planierschild

Lasthöhe m (ft)	Lastradius								Max. Reichweite		
	1,5 m (4.9 ft)		3,0 m (9.8 ft)		4,5 m (14.8 ft)		6,0 m (19.7 ft)		Volumen	Reichweite	
											
6,0 m (19.7 ft)	kg								*3360	*3360	4,26
	lb								*7410	*7410	(14.0)
4,5 m (14.8 ft)	kg					*4370	4120		*2990	*2990	5,43
	lb					*9630	9080		*6590	*6590	(17.8)
3,0 m (9.8 ft)	kg			*6740	*6740	*5110	3970	*3030	2550	*2960	6,01
	lb			*14860	*14860	*11270	8750	*6680	5620	*6530	(19.7)
1,5 m (4.9 ft)	kg			*9580	6890	5790	3780	3720	2500	*3160	6,17
	lb			*21120	15190	12760	8330	8200	5510	*6970	(20.2)
Boden- niveau	kg			*10620	6640	5640	3640			*3650	5,95
	lb			*23410	14640	12430	8020			*8050	(19.5)
-1,5 m (-4.9 ft)	kg	*7660	*7660	*10090	6630	5600	3610			4390	5,30
	lb	*16890	*16890	*22240	14620	12350	7960			9680	(17.4)
-3,0 m (-9.8 ft)	kg			*7830	6790					*5510	4,02
	lb			*17260	14970					*12150	(13.2)

Ausleger : 4,1 m (13' 5") / Löffelstiel : 2,1 m (6' 11") / Bodenplatten : 600 mm (24") 3-Stege-Bodenplatte / Heckgegengewicht : 2000 kg / Planierschild abgesenkt

Lasthöhe m (ft)	Lastradius								Max. Reichweite		
	1,5 m (4.9 ft)		3,0 m (9.8 ft)		4,5 m (14.8 ft)		6,0 m (19.7 ft)		Volumen	Reichweite	
											
6,0 m (19.7 ft)	kg								*3360	*3360	4,26
	lb								*7410	*7410	(14.0)
4,5 m (14.8 ft)	kg					*4370	*4370		*2990	*2990	5,43
	lb					*9630	*9630		*6590	*6590	(17.8)
3,0 m (9.8 ft)	kg			*6740	*6740	*5110	4520	*3030	2910	*2960	6,01
	lb			*14860	*14860	*11270	9960	*6680	6420	*6530	(19.7)
1,5 m (4.9 ft)	kg			*9580	8000	*6140	4320	*4480	2850	*3160	6,17
	lb			*21120	17640	*13540	9520	*9880	6280	*6970	(20.2)
Boden- niveau	kg			*10620	7730	*6800	4180			*3650	5,95
	lb			*23410	17040	*14990	9220			*8050	(19.5)
-1,5 m (-4.9 ft)	kg	*7660	*7660	*10090	7720	*6650	4150			*4800	5,30
	lb	*16890	*16890	*22240	17020	*14660	9150			*10580	(17.4)
-3,0 m (-9.8 ft)	kg			*7830	*7830					*5510	4,02
	lb			*17260	*17260					*12150	(13.2)

Ausleger : 4,1 m (13' 5") / Löffelstiel : 2,1 m (6' 11") / Bodenplatten : 600 mm (24") 3-Stege-Bodenplatte / Heckgegengewicht : 2000 kg / Planierschild gehoben











Lasthöhe m (ft)	Lastradius								Max. Reichweite		
	1,5 m (4.9 ft)		3,0 m (9.8 ft)		4,5 m (14.8 ft)		6,0 m (19.7 ft)		Volumen	Reichweite	
											
6,0 m (19.7 ft)	kg								*3360	*3360	4,26
	lb								*7410	*7410	(14.0)
4,5 m (14.8 ft)	kg					*4370	4320		*2990	*2990	5,43
	lb					*9630	9520		*6590	*6590	(17.8)
3,0 m (9.8 ft)	kg			*6740	*6740	*5110	4170	*3030	2700	*2960	6,01
	lb			*							

HUBVERMÖGEN











 Lastradius Frontauslage  Lastradius Seitenauslage bzw. 360 Grad

HX140L C











Ausleger : 4,1 m (13' 5") / Löffelstiel : 2,5 m (8' 2") / Bodenplatten : 600 mm (24") 3-Stege-Bodenplatte / Heckgegengewicht : 2000 kg / Ohne Planierschild

Lasthöhe m (ft)	Lastradius								Max. Reichweite		
	1,5 m (4.9 ft)		3,0 m (9.8 ft)		4,5 m (14.8 ft)		6,0 m (19.7 ft)		Volumen	Reichweite	
											m (ft)
6,0 m (19.7 ft)	kg				*3210	*3210			*2210	*2210	4,85
	lb				*7080	*7080			*4870	*4870	(15.9)
4,5 m (14.8 ft)	kg				*3890	*3890			*1980	*1980	5,90
	lb				*8580	*8580			*4370	*4370	(19.3)
3,0 m (9.8 ft)	kg		*5830	*5830	*4690	4000	*3610	2570	*1950	*1950	6,43
	lb		*12850	*12850	*10340	8820	*7960	5670	*4300	*4300	(21.1)
1,5 m (4.9 ft)	kg		*8870	6980	*5800	3790	3710	2490	*2050	*2050	6,58
	lb		*19550	15390	*12790	8360	8180	5490	*4520	*4520	(21.6)
Boden- niveau	kg		*10430	6620	5620	3620	3640	2420	*2310	2220	6,38
	lb		*22990	14590	12390	7980	8020	5340	*5090	4890	(20.9)
-1,5 m (-4.9 ft)	kg	*6570	*6570	*10330	6550	5550	3560		*2890	2540	5,78
	lb	*14480	*14480	*22770	14440	12240	7850		*6370	5600	(19.0)
-3,0 m (-9.8 ft)	kg	*11700	*11700	*8660	6670	*5420	3640		*4570	3510	4,63
	lb	*25790	*25790	*19090	14700	*11950	8020		*10080	7740	(15.2)

Ausleger : 4,1 m (13' 5") / Löffelstiel : 2,5 m (8' 2") / Bodenplatten : 600 mm (24") 3-Stege-Bodenplatte / Heckgegengewicht : 2000 kg / Planierschild abgesenkt

Lasthöhe m (ft)	Lastradius								Max. Reichweite		
	1,5 m (4.9 ft)		3,0 m (9.8 ft)		4,5 m (14.8 ft)		6,0 m (19.7 ft)		Volumen	Reichweite	
											m (ft)
6,0 m (19.7 ft)	kg				*3210	*3210			*2210	*2210	4,85
	lb				*7080	*7080			*4870	*4870	(15.9)
4,5 m (14.8 ft)	kg				*3890	*3890			*1980	*1980	5,90
	lb				*8580	*8580			*4370	*4370	(19.3)
3,0 m (9.8 ft)	kg		*5830	*5830	*4690	4550	*3610	2920	*1950	*1950	6,43
	lb		*12850	*12850	*10340	10030	*7960	6440	*4300	*4300	(21.1)
1,5 m (4.9 ft)	kg		*8870	8090	*5800	4330	*4650	2840	*2050	*2050	6,58
	lb		*19550	17840	*12790	9550	*10250	6260	*4520	*4520	(21.6)
Boden- niveau	kg		*10430	7720	*6630	4160	*4830	2770	*2310	*2310	6,38
	lb		*22990	17020	*14620	9170	*10650	6110	*5090	*5090	(20.9)
-1,5 m (-4.9 ft)	kg	*6570	*6570	*10330	7650	*6740	4100		*2890	*2890	5,78
	lb	*14480	*14480	*22770	16870	*14860	9040		*6370	*6370	(19.0)
-3,0 m (-9.8 ft)	kg	*11700	*11700	*8660	7770	*5420	4180		*4570	4030	4,63
	lb	*25790	*25790	*19090	17130	*11950	9220		*10080	8880	(15.2)

Ausleger : 4,1 m (13' 5") / Löffelstiel : 2,5 m (8' 2") / Bodenplatten : 600 mm (24") 3-Stege-Bodenplatte / Heckgegengewicht : 2000 kg / Planierschild gehoben

Lasthöhe m (ft)	Lastradius								Max. Reichweite		
	1,5 m (4.9 ft)		3,0 m (9.8 ft)		4,5 m (14.8 ft)		6,0 m (19.7 ft)		Volumen	Reichweite	
											m (ft)
6,0 m (19.7 ft)	kg				*3210	*3210			*2210	*2210	4,85
	lb				*7080	*7080			*4870	*4870	(15.9)
4,5 m (14.8 ft)	kg				*3890	*3890			*1980	*1980	5,90
	lb				*8580	*8580			*4370	*4370	(19.3)
3,0 m (9.8 ft)	kg		*5830	*5830	*4690	4210	*3610	2710	*1950	*1950	6,43
	lb		*12850	*12850	*10340	9280	*7960	5970	*4300	*4300	(21.1)
1,5 m (4.9 ft)	kg		*8870	7340	*5800	3990	3710	2630	*2050	*2050	6,58
	lb		*19550	16180	*12790	8800	8180	5800	*4520	*4520	(21.6)
Boden- niveau	kg		*10430	6980	5620	3830	3640	2560	*2310	*2310	6,38
	lb		*22990	15390	12390	8440	8020	5640	*5090	*5090	(20.9)
-1,5 m (-4.9 ft)	kg	*6570	*6570	*10330	6910	5550	3770		*2890	2690	5,78
	lb	*14480	*14480	*22770	15230	12240	8310		*6370	5930	(19.0)
-3,0 m (-9.8 ft)	kg	*11700	*11700	*8660	7030	*5420	3850		*4570	3710	4,63
	lb	*25790	*25790	*19090	15500	*11950	8490		*10080	8180	(15.2)

- Die Hublast richtet sich nach der Definition in SAE J1097 und ISO 10567.
- Die Hublast der Serie HX darf auf festem, ebenem Untergrund maximal 75 % der Kipplast der Maschine bzw. 87 % der gesamten hydraulischen Hubkraft betragen.











- Der Lasthaken befindet sich an der Rückseite des Tieflöffels.
- (*) gibt die Lastbegrenzung durch die hydraulische Hubkraft an.

HUBVERMÖGEN











 Lastradius Frontauslage  Lastradius Seitenauslage bzw. 360 Grad

HX140L C



Ausleger : 4,6 m (15' 1") / Löffelstiel : 1,9 m (6' 3") / Bodenplatten : 600 mm (24") 3-Stege-Bodenplatte / Heckgegengewicht : 2000 kg / Ohne Planierschild

Lasthöhe m (ft)	Lastradius								Max. Reichweite								
	1,5 m (4.9 ft)		3,0 m (9.8 ft)		4,5 m (14.8 ft)		6,0 m (19.7 ft)		Volumen	Reichweite							
											m (ft)						
6,0 m (19.7 ft)	kg								*4200	4120	*3650	*3650	4,73				
	lb								*9260	9080	*8050	*8050	(15.5)				
4,5 m (14.8 ft)	kg								*4330	4070	*3340	2720	5,80				
	lb								*9550	8970	*7360	6000	(19.0)				
3,0 m (9.8 ft)	kg								*5220	3880	3760	2530	6,35				
	lb								*11510	8550	8290	5580	(20.8)				
1,5 m (4.9 ft)	kg								5670	3680	3680	2460	6,50				
	lb								12500	8110	8110	5420	(21.3)				
Boden- niveau	kg								*5750	*5750	5540	3550	3620	2400	3380	2260	6,29
	lb								*12680	*12680	12210	7830	7980	5290	7450	4980	(20.6)
-1,5 m (-4.9 ft)	kg	*5700	*5700	*9710	6520	5520	3540		*6600	4070	*4960	2970	5,68				
	lb	*12570	*12570	*21410	14370	12170	7800		*14550	8970	*10930	6550	(18.6)				
-3,0 m (-9.8 ft)	kg								*7880	6670	*5080	3640	4,51				
	lb								*17370	14700	*11200	8020	(14.8)				

Ausleger : 4,6 m (15' 1") / Löffelstiel : 1,9 m (6' 3") / Bodenplatten : 600 mm (24") 3-Stege-Bodenplatte / Heckgegengewicht : 2000 kg / Planierschild abgesenkt

Lasthöhe m (ft)	Lastradius								Max. Reichweite								
	1,5 m (4.9 ft)		3,0 m (9.8 ft)		4,5 m (14.8 ft)		6,0 m (19.7 ft)		Volumen	Reichweite							
											m (ft)						
6,0 m (19.7 ft)	kg								*4200	*4200	*3650	*3650	4,73				
	lb								*9260	*9260	*8050	*8050	(15.5)				
4,5 m (14.8 ft)	kg								*4330	*4330	*3340	3090	5,80				
	lb								*9550	*9550	*7360	6810	(19.0)				
3,0 m (9.8 ft)	kg								*5220	4420	*4420	2890	6,35				
	lb								*11510	9740	*9740	6370	(20.8)				
1,5 m (4.9 ft)	kg								*6220	4210	*4790	2810	6,50				
	lb								*13710	9280	*10560	6190	(21.3)				
Boden- niveau	kg								*5750	*5750	*6760	4090	*4990	2750	*4050	2590	6,29
	lb								*12680	*12680	*14900	9020	*11000	6060	*8930	5710	(20.6)
-1,5 m (-4.9 ft)	kg	*5700	*5700	*9710	7610	*6600	4070		*6600	4070	*4960	2970	5,68				
	lb	*12570	*12570	*21410	16780	*14550	8970		*14550	8970	*10930	6550	(18.6)				
-3,0 m (-9.8 ft)	kg								*7880	7770	*5080	4180	4,51				
	lb								*17370	17130	*11200	9220	(14.8)				

Ausleger : 4,6 m (15' 1") / Löffelstiel : 1,9 m (6' 3") / Bodenplatten : 600 mm (24") 3-Stege-Bodenplatte / Heckgegengewicht : 2000 kg / Planierschild gehoben











Lasthöhe m (ft)	Lastradius								Max. Reichweite	
	1,5 m (4.9 ft)		3,0 m (9.8 ft)		4,5 m (14.8 ft)		6,0 m (19.7 ft)		Volumen	Reichweite
										

HUBVERMÖGEN











 Lastradius Frontauslage  Lastradius Seitenauslage bzw. 360 Grad

HX140L C











Ausleger : 4,6 m (15' 1") / Löffelstiel : 1,9 m (6' 3") / Bodenplatten : 600 mm (24") 3-Stege-Bodenplatte / Heckgegengewicht : 2300 kg / Ohne Planierschild

Lasthöhe m (ft)	Lastradius								Max. Reichweite			
	1,5 m (4.9 ft)		3,0 m (9.8 ft)		4,5 m (14.8 ft)		6,0 m (19.7 ft)		Volumen	Reichweite		
											m (ft)	
6,0 m (19.7 ft)	kg											
	lb											
4,5 m (14.8 ft)	kg											
	lb											
3,0 m (9.8 ft)	kg											
	lb											
1,5 m (4.9 ft)	kg											
	lb											
Boden- niveau	kg											
	lb											
-1,5 m (-4.9 ft)	kg											
	lb											
-3,0 m (-9.8 ft)	kg											
	lb											

Ausleger : 4,6 m (15' 1") / Löffelstiel : 1,9 m (6' 3") / Bodenplatten : 600 mm (24") 3-Stege-Bodenplatte / Heckgegengewicht : 2300 kg / Planierschild abgesenkt

Lasthöhe m (ft)	Lastradius								Max. Reichweite			
	1,5 m (4.9 ft)		3,0 m (9.8 ft)		4,5 m (14.8 ft)		6,0 m (19.7 ft)		Volumen	Reichweite		
											m (ft)	
6,0 m (19.7 ft)	kg											
	lb											
4,5 m (14.8 ft)	kg											
	lb											
3,0 m (9.8 ft)	kg											
	lb											
1,5 m (4.9 ft)	kg											
	lb											
Boden- niveau	kg											
	lb											
-1,5 m (-4.9 ft)	kg											
	lb											
-3,0 m (-9.8 ft)	kg											
	lb											



Ausleger : 4,6 m (15' 1") / Löffelstiel : 1,9 m (6' 3") / Bodenplatten : 600 mm (24") 3-Stege-Bodenplatte / Heckgegengewicht : 2300 kg / Planierschild gehoben

Lasthöhe m (ft)	Lastradius								Max. Reichweite			
	1,5 m (4.9 ft)		3,0 m (9.8 ft)		4,5 m (14.8 ft)		6,0 m (19.7 ft)		Volumen	Reichweite		
											m (ft)	
6,0 m (19.7 ft)	kg											
	lb											
4,5 m (14.8 ft)	kg											
	lb											
3,0 m (9.8 ft)	kg											
	lb											
1,5 m (4.9 ft)	kg											
	lb											
Boden- niveau	kg											
	lb											
-1,5 m (-4.9 ft)	kg											
	lb											
-3,0 m (-9.8 ft)	kg											
	lb											

- Die Hublast richtet sich nach der Definition in SAE J1097 und ISO 10567.
- Die Hublast der Serie HX darf auf festem, ebenem Untergrund maximal 75 % der Kipplast der Maschine bzw. 87 % der gesamten hydraulischen Hubkraft betragen.











- Der Lasthaken befindet sich an der Rückseite des Tieflöffels.
- (*) gibt die Lastbegrenzung durch die hydraulische Hubkraft an.

HUBVERMÖGEN











 Lastradius Frontauslage  Lastradius Seitenauslage bzw. 360 Grad

HX140L C











Ausleger : 4,6 m (15' 1") / Löffelstiel : 2,1 m (6' 11") / Bodenplatten : 600 mm (24") 3-Stege-Bodenplatte / Heckgegengewicht : 2000 kg / Ohne Planierschild

Lasthöhe m (ft)	Lastradius								Max. Reichweite			
	1,5 m (4.9 ft)		3,0 m (9.8 ft)		4,5 m (14.8 ft)		6,0 m (19.7 ft)		Volumen	Reichweite		
											m (ft)	
6,0 m (19.7 ft)	kg											
	lb											
4,5 m (14.8 ft)	kg											
	lb											
3,0 m (9.8 ft)	kg											
	lb											
1,5 m (4.9 ft)	kg											
	lb											
Boden- niveau	kg											
	lb											
-1,5 m (-4.9 ft)	kg											
	lb											
-3,0 m (-9.8 ft)	kg											
	lb											

Ausleger : 4,6 m (15' 1") / Löffelstiel : 2,1 m (6' 11") / Bodenplatten : 600 mm (24") 3-Stege-Bodenplatte / Heckgegengewicht : 2000 kg / Planierschild abgesenkt

Lasthöhe m (ft)	Lastradius								Max. Reichweite			
	1,5 m (4.9 ft)		3,0 m (9.8 ft)		4,5 m (14.8 ft)		6,0 m (19.7 ft)		Volumen	Reichweite		
											m (ft)	
6,0 m (19.7 ft)	kg											
	lb											
4,5 m (14.8 ft)	kg											
	lb											
3,0 m (9.8 ft)	kg											
	lb											
1,5 m (4.9 ft)	kg											
	lb											
Boden- niveau	kg											
	lb											
-1,5 m (-4.9 ft)	kg											
	lb											
-3,0 m (-9.8 ft)	kg											
	lb											

Ausleger : 4,6 m (15' 1") / Löffelstiel : 2,1 m (6' 11") / Bodenplatten : 600 mm (24") 3-Stege-Bodenplatte / Heckgegengewicht : 2000 kg / Planierschild gehoben

Lasthöhe m (ft)	Lastradius								Max. Reichweite			
	1,5 m (4.9 ft)		3,0 m (9.8 ft)		4,5 m (14.8 ft)		6,0 m (19.7 ft)		Volumen	Reichweite		
											m (ft)	
6,0 m (19.7 ft)	kg											
	lb											
4,5 m (14.8 ft)	kg											
	lb											
3,0 m (9.8 ft)	kg											
	lb											
1,5 m (4.9 ft)	kg											
	lb											
Boden- niveau	kg											
	lb											
-1,5 m (-4.9 ft)	kg											
	lb											
-3,0 m (-9.8 ft)	kg											
	lb											

- Die Hublast richtet sich nach der Definition in SAE J1097 und ISO 10567.
- Die Hublast der Serie HX darf auf festem, ebenem Untergrund maximal 75 % der Kipplast der Maschine bzw. 87 % der gesamten hydraulischen Hubkraft betragen.









- Der Lasthaken befindet sich an der Rückseite des Tieflöffels.
- (*) gibt die Lastbegrenzung durch die hydraulische Hubkraft an.

HUBVERMÖGEN











 Lastradius Frontauslage  Lastradius Seitenauslage bzw. 360 Grad

HX140L C











Ausleger : 4,6 m (15' 1") / Löffelstiel : 2,1 m (6' 11") / Bodenplatten : 600 mm (24") 3-Stege-Bodenplatte / Heckgegengewicht : 2300 kg / Ohne Planierschild

Lasthöhe m (ft)	Lastradius								Max. Reichweite		
	1,5 m (4.9 ft)		3,0 m (9.8 ft)		4,5 m (14.8 ft)		6,0 m (19.7 ft)		Volumen	Reichweite	
											m (ft)
6,0 m (19.7 ft)	kg				*3910	*3910			*3470	*3470	4,97
	lb				*8620	*8620			*7650	*7650	(16.3)
4,5 m (14.8 ft)	kg				*4120	*4120			*3210	2730	5,99
	lb				*9080	*9080			*7080	6020	(19.7)
3,0 m (9.8 ft)	kg		*7310	*7310	*5030	4100	3940	2680	*3220	2350	6,52
	lb		*16120	*16120	*11090	9040	8690	5910	*7100	5180	(21.4)
1,5 m (4.9 ft)	kg				5940	3880	3850	2590	3290	2220	6,67
	lb				13100	8550	8490	5710	7250	4890	(21.9)
Boden- niveau	kg		*6160	*6160	5790	3740	3780	2530	3400	2290	6,47
	lb		*13580	*13580	12760	8250	8330	5580	7500	5050	(21.2)
-1,5 m (-4.9 ft)	kg	*5500	*5500	*9870	6840	5750	3710		3890	2600	5,88
	lb	*12130	*12130	*21760	15080	12680	8180		8580	5730	(19.3)
-3,0 m (-9.8 ft)	kg			*8230	6980	*5470	3800		*5000	3540	4,75
	lb			*18140	15390	*12060	8380		*11020	7800	(15.6)

Ausleger : 4,6 m (15' 1") / Löffelstiel : 2,1 m (6' 11") / Bodenplatten : 600 mm (24") 3-Stege-Bodenplatte / Heckgegengewicht : 2300 kg / Planierschild abgesenkt

Lasthöhe m (ft)	Lastradius								Max. Reichweite		
	1,5 m (4.9 ft)		3,0 m (9.8 ft)		4,5 m (14.8 ft)		6,0 m (19.7 ft)		Volumen	Reichweite	
											m (ft)
6,0 m (19.7 ft)	kg				*3910	*3910			*3470	*3470	4,97
	lb				*8620	*8620			*7650	*7650	(16.3)
4,5 m (14.8 ft)	kg				*4120	*4120			*3210	3090	5,99
	lb				*9080	*9080			*7080	6810	(19.7)
3,0 m (9.8 ft)	kg		*7310	*7310	*5030	4650	*4280	3040	*3220	2670	6,52
	lb		*16120	*16120	*11090	10250	*9440	6700	*7100	5890	(21.4)
1,5 m (4.9 ft)	kg				*6070	4430	*4680	2950	*3430	2530	6,67
	lb				*13380	9770	*10320	6500	*7560	5580	(21.9)
Boden- niveau	kg		*6160	*6160	*6690	4290	*4950	2890	*3910	2610	6,47
	lb		*13580	*13580	*14750	9460	*10910	6370	*8620	5750	(21.2)
-1,5 m (-4.9 ft)	kg	*5500	*5500	*9870	7950	*6630	4260		*4820	2970	5,88
	lb	*12130	*12130	*21760	17530	*14620	9390		*10630	6550	(19.3)
-3,0 m (-9.8 ft)	kg			*8230	8100	*5470	4350		*5000	4040	4,75
	lb			*18140	17860	*12060	9590		*11020	8910	(15.6)



Ausleger : 4,6 m (15' 1") / Löffelstiel : 2,1 m (6' 11") / Bodenplatten : 600 mm (24") 3-Stege-Bodenplatte / Heckgegengewicht : 2300 kg / Planierschild gehoben

Lasthöhe m (ft)	Lastradius								Max. Reichweite		
	1,5 m (4.9 ft)		3,0 m (9.8 ft)		4,5 m (14.8 ft)		6,0 m (19.7 ft)		Volumen	Reichweite	
											m (ft)
6,0 m (19.7 ft)	kg				*3910	*3910			*3470	*3470	4,97
	lb				*8620	*8620			*7650	*7650	(16.3)
4,5 m (14.8 ft)	kg				*4120	*4120			*3210	2870	5,99
	lb				*9080	*9080			*7080	6330	(19.7)
3,0 m (9.8 ft)	kg		*7310	*7310	*5030	4300	3940	2820	*3220	2480	6,52
	lb		*16120	*16120	*11090	9480	8690	6220	*7100	5470	(21.4)
1,5 m (4.9 ft)	kg				5940	4080	3840	2730	3290	2350	6,67
	lb				13100	8990	8470	6020	7250	5180	(21.9)
Boden- niveau	kg		*6160	*6160	5780	3950	3780	2670	3400	2410	6,47
	lb		*13580	*13580	12740	8710	8330	5890	7500	5310	(21.2)
-1,5 m (-4.9 ft)	kg	*5500	*5500	*9870	7200	5750	3920		3890	2740	5,88
	lb	*12130	*12130	*21760	15870	12680	8640		8580	6040	(19.3)
-3,0 m (-9.8 ft)	kg			*8230	7340	*5470	4000		*5000	3730	4,75
	lb			*18140	16180	*12060	8820		*11020	8220	(15.6)

- Die Hublast richtet sich nach der Definition in SAE J1097 und ISO 10567.
- Die Hublast der Serie HX darf auf festem, ebenem Untergrund maximal 75 % der Kipplast der Maschine bzw. 87 % der gesamten hydraulischen Hubkraft betragen.











- Der Lasthaken befindet sich an der Rückseite des Tieflöffels.
- (*) gibt die Lastbegrenzung durch die hydraulische Hubkraft an.

HUBVERMÖGEN











 Lastradius Frontauslage  Lastradius Seitenauslage bzw. 360 Grad

HX140L C









Ausleger : 4,6 m (15' 1") / Löffelstiel : 2,5 m (8' 2") / Bodenplatten : 600 mm (24") 3-Stege-Bodenplatte / Heckgegengewicht : 2000 kg / Ohne Planierschild

Lasthöhe m (ft)	Lastradius								Max. Reichweite			
	1,5 m (4.9 ft)		3,0 m (9.8 ft)		4,5 m (14.8 ft)		6,0 m (19.7 ft)		Volumen	Reichweite		
											m (ft)	
6,0 m (19.7 ft)	kg								*3400	*3400	5,50	
	lb								*7500	*7500	(18.0)	
4,5 m (14.8 ft)	kg								*3700	*3700	6,44	
	lb								*8160	*8160	(21.1)	
3,0 m (9.8 ft)	kg			*6380	*6380	*4630	3920	3770	2610	*2200	2010	6,93
	lb			*14070	*14070	*10210	8640	8310	5600	*4850	4430	(22.7)
1,5 m (4.9 ft)	kg			*7050	6670	5690	3680	3660	2430	*2320	1900	7,07
	lb			*15540	14700	12540	8110	8070	5360	*5110	4190	(23.2)
Boden- niveau	kg			*6550	6390	5500	3510	3570	2350	*2590	1950	6,88
	lb			*14440	14090	12130	7740	7870	5180	*5710	4300	(22.6)
-1,5 m (-4.9 ft)	kg	*4890	*4890	*10080	6370	5430	3450	3550	2330	*3160	2170	6,34
	lb	*10780	*10780	*22220	14040	11970	7610	7830	5140	*6970	4780	(20.8)
-3,0 m (-9.8 ft)	kg	*9020	*9020	*8820	6480	5490	3500			4300	2810	5,31
	lb	*19890	*19890	*19440	14290	12100	7720			9480	6190	(17.4)

Ausleger : 4,6 m (15' 1") / Löffelstiel : 2,5 m (8' 2") / Bodenplatten : 600 mm (24") 3-Stege-Bodenplatte / Heckgegengewicht : 2000 kg / Planierschild abgesenkt

Lasthöhe m (ft)	Lastradius								Max. Reichweite			
	1,5 m (4.9 ft)		3,0 m (9.8 ft)		4,5 m (14.8 ft)		6,0 m (19.7 ft)		Volumen	Reichweite		
											m (ft)	
6,0 m (19.7 ft)	kg								*3400	*3400	5,50	
	lb								*7500	*7500	(18.0)	
4,5 m (14.8 ft)	kg								*3700	*3700	6,44	
	lb								*8160	*8160	(21.1)	
3,0 m (9.8 ft)	kg			*6380	*6380	*4630	4470	*4000	2890	*2200	*2200	6,93
	lb			*14070	*14070	*10210	9850	*8820	6370	*4850	*4850	(22.7)
1,5 m (4.9 ft)	kg			*7050	*7050	*5760	4220	*4480	2790	*2320	2190	7,07
	lb			*15540	*15540	*12700	9300	*9880	6150	*5110	4830	(23.2)
Boden- niveau	kg			*6550	*6550	*6530	4050	*4850	2710	*2590	2240	6,88
	lb			*14440	*14440	*14400	8930	*10690	5970	*5710	4940	(22.6)
-1,5 m (-4.9 ft)	kg	*4890	*4890	*10080	7460	*6670	3990	*4820	2680	*3160	2500	6,34
	lb	*10780	*10780	*22220	16450	*14700	8800	*10630	5910	*6970	5510	(20.8)
-3,0 m (-9.8 ft)	kg	*9020	*9020	*8820	7580	*5920	4040			*4580	3230	5,31
	lb	*19890	*19890	*19440	16710	*13050	8910			*10100	7120	(17.4)

Ausleger : 4,6 m (15' 1") / Löffelstiel : 2,5 m (8' 2") / Bodenplatten : 600 mm (24") 3-Stege-Bodenplatte / Heckgegengewicht : 2000 kg / Planierschild gehoben











Lasthöhe m (ft)	Lastradius								Max. Reichweite	
	1,5 m (4.9 ft)		3,0 m (9.8 ft)		4,5 m (14.8 ft)		6,0 m (19.7 ft)		Volumen	Reichweite
										

HUBVERMÖGEN











 Lastradius Frontauslage  Lastradius Seitenauslage bzw. 360 Grad

HX140L C











Ausleger : 4,6 m (15' 1") / Löffelstiel : 2,5 m (8' 2") / Bodenplatten : 600 mm (24") 3-Stege-Bodenplatte / Heckgegengewicht : 2300 kg / Ohne Planierschild

Lasthöhe m (ft)	Lastradius								Max. Reichweite			
	1,5 m (4.9 ft)		3,0 m (9.8 ft)		4,5 m (14.8 ft)		6,0 m (19.7 ft)		Volumen	Reichweite		
											m (ft)	
6,0 m (19.7 ft)	kg				*3400	*3400			*2390	*2390	5,50	
	lb				*7500	*7500			*5270	*5270	(18.0)	
4,5 m (14.8 ft)	kg				*3700	*3700	*3500	2750	*2210	*2210	6,44	
	lb				*8160	*8160	*7720	6060	*4870	*4870	(21.1)	
3,0 m (9.8 ft)	kg		*6380	*6380	*4630	4130	3950	2680	*2200	2130	6,93	
	lb		*14070	*14070	*10210	9110	8710	5910	*4850	4700	(22.7)	
1,5 m (4.9 ft)	kg		*7050	7050	*5760	3890	3840	2580	*2320	2020	7,07	
	lb		*15540	15540	*12700	8580	8470	5690	*5110	4450	(23.2)	
Boden- niveau	kg		*6550	*6550	5770	3720	3750	2500	*2590	2070	6,88	
	lb		*14440	*14440	12720	8200	8270	5510	*5710	4560	(22.6)	
-1,5 m (-4.9 ft)	kg	*4890	*4890	*10080	6750	5700	3660	3730	2480	*3160	2310	6,34
	lb	*10780	*10780	*22220	14880	12570	8070	8220	5470	*6970	5090	(20.8)
-3,0 m (-9.8 ft)	kg	*9020	*9020	*8820	6860	5760	3710			4510	2980	5,31
	lb	*19890	*19890	*19440	15120	12700	8180			9940	6570	(17.4)

Ausleger : 4,6 m (15' 1") / Löffelstiel : 2,5 m (8' 2") / Bodenplatten : 600 mm (24") 3-Stege-Bodenplatte / Heckgegengewicht : 2300 kg / Planierschild abgesenkt

Lasthöhe m (ft)	Lastradius								Max. Reichweite			
	1,5 m (4.9 ft)		3,0 m (9.8 ft)		4,5 m (14.8 ft)		6,0 m (19.7 ft)		Volumen	Reichweite		
											m (ft)	
6,0 m (19.7 ft)	kg				*3400	*3400			*2390	*2390	5,50	
	lb				*7500	*7500			*5270	*5270	(18.0)	
4,5 m (14.8 ft)	kg				*3700	*3700	*3500	3110	*2210	*2210	6,44	
	lb				*8160	*8160	*7720	6860	*4870	*4870	(21.1)	
3,0 m (9.8 ft)	kg		*6380	*6380	*4630	*4630	*4000	3040	*2200	*2200	6,93	
	lb		*14070	*14070	*10210	*10210	*8820	6700	*4850	*4850	(22.7)	
1,5 m (4.9 ft)	kg		*7050	*7050	*5760	4440	*4480	2940	*2320	2310	7,07	
	lb		*15540	*15540	*12700	9790	*9880	6480	*5110	5090	(23.2)	
Boden- niveau	kg		*6550	*6550	*6530	4270	*4850	2860	*2590	2370	6,88	
	lb		*14440	*14440	*14400	9410	*10690	6310	*5710	5220	(22.6)	
-1,5 m (-4.9 ft)	kg	*4890	*4890	*10080	7860	*6670	4210	*4820	2830	*3160	2640	6,34
	lb	*10780	*10780	*22220	17330	*14700	9280	*10630	6240	*6970	5820	(20.8)
-3,0 m (-9.8 ft)	kg	*9020	*9020	*8820	7980	*5920	4260			*4580	3410	5,31
	lb	*19890	*19890	*19440	17590	*13050	9390			*10100	7520	(17.4)



Ausleger : 4,6 m (15' 1") / Löffelstiel : 2,5 m (8' 2") / Bodenplatten : 600 mm (24") 3-Stege-Bodenplatte / Heckgegengewicht : 2300 kg / Planierschild gehoben

Lasthöhe m (ft)	Lastradius								Max. Reichweite			
	1,5 m (4.9 ft)		3,0 m (9.8 ft)		4,5 m (14.8 ft)		6,0 m (19.7 ft)		Volumen	Reichweite		
											m (ft)	
6,0 m (19.7 ft)	kg				*3400	*3400			*2390	*2390	5,50	
	lb				*7500	*7500			*5270	*5270	(18.0)	
4,5 m (14.8 ft)	kg				*3700	*3700	*3500	2890	*2210	*2210	6,44	
	lb				*8160	*8160	*7720	6370	*4870	*4870	(21.1)	
3,0 m (9.8 ft)	kg		*6380	*6380	*4630	4340	3950	2820	*2200	*2200	6,93	
	lb		*14070	*14070	*10210	9570	8710	6220	*4850	*4850	(22.7)	
1,5 m (4.9 ft)	kg		*7050	*7050	*5760	4090	3840	2720	*2320	2140	7,07	
	lb		*15540	*15540	*12700	9020	8470	6000	*5110	4720	(23.2)	
Boden- niveau	kg		*6550	*6550	5770	3930	3750	2640	*2590	2190	6,88	
	lb		*14440	*14440	12720	8660	8270	5820	*5710	4830	(22.6)	
-1,5 m (-4.9 ft)	kg	*4890	*4890	*10080	7110	5700	3870	3720	2620	*3160	2440	6,34
	lb	*10780	*10780	*22220	15670	12570	8530	8200	5780	*6970	5380	(20.8)
-3,0 m (-9.8 ft)	kg	*9020	*9020	*8820	7220	5760	3920			4510	3150	5,31
	lb	*19890	*19890	*19440	15920	12700	8640			9940	6940	(17.4)

- Die Hublast richtet sich nach der Definition in SAE J1097 und ISO 10567.
- Die Hublast der Serie HX darf auf festem, ebenem Untergrund maximal 75 % der Kipplast der Maschine bzw. 87 % der gesamten hydraulischen Hubkraft betragen.











- Der Lasthaken befindet sich an der Rückseite des Tieflöffels.
- (*) gibt die Lastbegrenzung durch die hydraulische Hubkraft an.

HUBVERMÖGEN











 Lastradius Frontauslage  Lastradius Seitenauslage bzw. 360 Grad

HX140L C

Ausleger : 4,6 m (15' 1") / Löffelstiel : 3,0 m (9' 10") / Bodenplatten : 600 mm (24") 3-Stege-Bodenplatte / Heckgegengewicht : 2000 kg / Ohne Planierschild

Lasthöhe m (ft)	Lastradius								Max. Reichweite				
	1,5 m (4.9 ft)		3,0 m (9.8 ft)		4,5 m (14.8 ft)		6,0 m (19.7 ft)		Volumen	Reichweite			
											m (ft)		
6,0 m (19.7 ft)	kg								*2230	*2230	*2000	*2000	6,08
	lb								*4920	*4920	*4410	*4410	(20.0)
4,5 m (14.8 ft)	kg								*3280	2640	*1880	*1880	6,94
	lb								*7230	5820	*4140	*4140	(22.8)
3,0 m (9.8 ft)	kg			*5250	*5250	*4130	3990		*3670	2560	*1870	1810	7,40
	lb			*11570	*11570	*9110	8800		*8090	5640	*4120	3990	(24.3)
1,5 m (4.9 ft)	kg			*8390	6840	*5340	3720		3670	2440	*1970	1720	7,53
	lb			*18500	15080	*11770	8200		8090	5380	*4340	3790	(24.7)
Boden- niveau	kg			*7180	6420	5510	3520		3560	2340	*2180	1750	7,36
	lb			*15830	14150	12150	7760		7850	5160	*4810	3860	(24.1)
-1,5 m (-4.9 ft)	kg	*4370	*4370	*9280	6320	5400	3430		3510	2290	*2610	1920	6,85
	lb	*9630	*9630	*20460	13930	11900	7560		7740	5050	*5750	4230	(22.5)
-3,0 m (-9.8 ft)	kg	*7550	*7550	*9420	6380	5420	3440				*3560	2380	5,91
	lb	*16640	*16640	*20770	14070	11950	7580				*7850	5250	(19.4)

Ausleger : 4,6 m (15' 1") / Löffelstiel : 3,0 m (9' 10") / Bodenplatten : 600 mm (24") 3-Stege-Bodenplatte / Heckgegengewicht : 2000 kg / Planierschild abgesenkt











Lasthöhe m (ft)	Lastradius								Max. Reichweite				
	1,5 m (4.9 ft)		3,0 m (9.8 ft)		4,5 m (14.8 ft)		6,0 m (19.7 ft)		Volumen	Reichweite			
											m (ft)		
6,0 m (19.7 ft)	kg								*2230	*2230	*2000	*2000	6,08
	lb								*4920	*4920	*4410	*4410	(20.0)
4,5 m (14.8 ft)	kg								*3280	3000	*1880	*1880	6,94
	lb								*7230	6610	*4140	*4140	(22.8)
3,0 m (9.8 ft)	kg			*5250	*5250	*4130	*4130		*3670	2910	*1870	*1870	7,40
	lb			*11570	*11570	*9110	*9110		*8090	6420	*4120	*4120	(24.3)
1,5 m (4.9 ft)	kg			*8390	7960	*5340	4270		*4220	2800	*1970	*1970	7,53
	lb			*18500	17550	*11770	9410		*9300	6170	*4340	*4340	(24.7)
Boden- niveau	kg			*7180	*7180	*6290	4060		*4700	2700	*2180	2020	7,36
	lb			*15830	*15830	*13870	8950		*10360	5950	*4810	4450	(24.1)
-1,5 m (-4.9 ft)	kg	*4370	*4370	*9280	7410	*6660	3960		*4860	2650	*2610	2220	6,85
	lb	*9630	*9630	*20460	16340	*14680	8730		*10710	5840	*5750	4890	(22.5)
-3,0 m (-9.8 ft)	kg	*7550	*7550	*9420	7480	*6270	3970				*3560	2740	5,91
	lb	*16640</											

HUBVERMÖGEN











 Lastradius Frontauslage  Lastradius Seitenauslage bzw. 360 Grad

HX140L C











Ausleger : 4,6 m (15' 1") / Löffelstiel : 3,0 m (9' 10") / Bodenplatten : 600 mm (24") 3-Stege-Bodenplatte / Heckgegengewicht : 2300 kg / Ohne Planierschild

Lasthöhe m (ft)	Lastradius								Max. Reichweite			
	1,5 m (4.9 ft)		3,0 m (9.8 ft)		4,5 m (14.8 ft)		6,0 m (19.7 ft)		Volumen	Reichweite		
											m (ft)	
6,0 m (19.7 ft)	kg							*2230	*2230	*2000	*2000	6,08
	lb							*4920	*4920	*4410	*4410	(20.0)
4,5 m (14.8 ft)	kg							*3280	2790	*1880	*1880	6,94
	lb							*7230	6150	*4140	*4140	(22.8)
3,0 m (9.8 ft)	kg			*5250	*5250	*4130	*4130	*3670	2700	*1870	*1870	7,40
	lb			*11570	*11570	*9110	*9110	*8090	5950	*4120	*4120	(24.3)
1,5 m (4.9 ft)	kg			*8390	7220	*5340	3930	3850	2590	*1970	1830	7,53
	lb			*18500	15920	*11770	8660	8490	5710	*4340	4030	(24.7)
Boden- niveau	kg			*7180	6800	5780	3730	3740	2490	*2180	1860	7,36
	lb			*15830	14990	12740	8220	8250	5490	*4810	4100	(24.1)
-1,5 m (-4.9 ft)	kg	*4370	*4370	*9280	6690	5680	3640	3690	2440	*2610	2050	6,85
	lb	*9630	*9630	*20460	14750	12520	8020	8140	5380	*5750	4520	(22.5)
-3,0 m (-9.8 ft)	kg	*7550	*7550	*9420	6760	5690	3650			*3560	2530	5,91
	lb	*16640	*16640	*20770	14900	12540	8050			*7850	5580	(19.4)

Ausleger : 4,6 m (15' 1") / Löffelstiel : 3,0 m (9' 10") / Bodenplatten : 600 mm (24") 3-Stege-Bodenplatte / Heckgegengewicht : 2300 kg / Planierschild abgesenkt

Lasthöhe m (ft)	Lastradius								Max. Reichweite			
	1,5 m (4.9 ft)		3,0 m (9.8 ft)		4,5 m (14.8 ft)		6,0 m (19.7 ft)		Volumen	Reichweite		
											m (ft)	
6,0 m (19.7 ft)	kg							*2230	*2230	*2000	*2000	6,08
	lb							*4920	*4920	*4410	*4410	(20.0)
4,5 m (14.8 ft)	kg							*3280	3150	*1880	*1880	6,94
	lb							*7230	6940	*4140	*4140	(22.8)
3,0 m (9.8 ft)	kg			*5250	*5250	*4130	*4130	*3670	3060	*1870	*1870	7,40
	lb			*11570	*11570	*9110	*9110	*8090	6750	*4120	*4120	(24.3)
1,5 m (4.9 ft)	kg			*8390	8360	*5340	4490	*4220	2950	*1970	*1970	7,53
	lb			*18500	18430	*11770	9900	*9300	6500	*4340	*4340	(24.7)
Boden- niveau	kg			*7180	*7180	*6290	4280	*4700	2850	*2180	2140	7,36
	lb			*15830	*15830	*13870	9440	*10360	6280	*4810	4720	(24.1)
-1,5 m (-4.9 ft)	kg	*4370	*4370	*9280	7810	*6660	4180	*4860	2800	*2610	2350	6,85
	lb	*9630	*9630	*20460	17220	*14680	9220	*10710	6170	*5750	5180	(22.5)
-3,0 m (-9.8 ft)	kg	*7550	*7550	*9420	7880	*6270	4190			*3560	2890	5,91
	lb	*16640	*16640	*20770	17370	*13820	9240			*7850	6370	(19.4)

Ausleger : 4,6 m (15' 1") / Löffelstiel : 3,0 m (9' 10") / Bodenplatten : 600 mm (24") 3-Stege-Bodenplatte / Heckgegengewicht : 2300 kg / Planierschild gehoben

Lasthöhe m (ft)	Lastradius								Max. Reichweite			
	1,5 m (4.9 ft)		3,0 m (9.8 ft)		4,5 m (14.8 ft)		6,0 m (19.7 ft)		Volumen	Reichweite		
											m (ft)	
6,0 m (19.7 ft)	kg							*2230	*2230	*2000	*2000	6,08
	lb							*4920	*4920	*4410	*4410	(20.0)
4,5 m (14.8 ft)	kg							*3280	2930	*1880	*1880	6,94
	lb							*7230	6460	*4140	*4140	(22.8)
3,0 m (9.8 ft)	kg			*5250	*5250	*4130	*4130	*3670	2840	*1870	*1870	7,40
	lb			*11570	*11570	*9110	*9110	*8090	6260	*4120	*4120	(24.3)
1,5 m (4.9 ft)	kg			*8390	7580	*5340	4140	3850	2730	*1970	1940	7,53
	lb			*18500	16710	*11770	9130	8490	6020	*4340	4280	(24.7)
Boden- niveau	kg			*7180	7160	5780	3930	3740	2630	*2180	1970	7,36
	lb			*15830	15790	12740	8660	8250	5800	*4810	4340	(24.1)
-1,5 m (-4.9 ft)	kg	*4370	*4370	*9280	7060	5670	3840	3690	2580	*2610	2170	6,85
	lb	*9630	*9630	*20460	15560	12500	8470	8140	5690	*5750	4780	(22.5)
-3,0 m (-9.8 ft)	kg	*7550	*7550	*9420	7120	5690	3850			*3560	2670	5,91
	lb	*16640	*16640	*20770	15700	12540	8490			*7850	5890	(19.4)

- Die Hublast richtet sich nach der Definition in SAE J1097 und ISO 10567.
- Die Hublast der Serie HX darf auf festem, ebenem Untergrund maximal 75 % der Kipplast der Maschine bzw. 87 % der gesamten hydraulischen Hubkraft betragen.











- Der Lasthaken befindet sich an der Rückseite des Tieflöffels.
- (*) gibt die Lastbegrenzung durch die hydraulische Hubkraft an.

HUBVERMÖGEN











 Lastradius Frontauslage  Lastradius Seitenauslage bzw. 360 Grad

HX140L C 2-TEILIGER AUSLEGER









Ausleger : 4,9 m (16' 1") / Löffelstiel : 1,9 m (6' 3") / Bodenplatten : 600 mm (24") 3-Stege-Bodenplatte / Heckgegengewicht : 2300 kg / Ohne Planierschild

Lasthöhe m (ft)	Lastradius								Max. Reichweite			
	3,0 m (9.8 ft)		4,5 m (14.8 ft)		6,0 m (19.7 ft)		7,5 m (24.6 ft)		Volumen	Reichweite		
											m (ft)	
7,5 m (24.6 ft)	kg									*4720	*4720	3,42
	lb									*10410	*10410	(11.2)
6,0 m (19.7 ft)	kg					*4060	*4060			*4310	3380	5,27
	lb					*8950	*8950			*9500	7450	(17.3)
4,5 m (14.8 ft)	kg	*5420	*5420	*4480	4280	4020	2730			3760	2550	6,24
	lb	*11950	*11950	*9880	9440	8860	6020			8290	5620	(20.5)
3,0 m (9.8 ft)	kg			*5550	4040	3950	2660			3280	2220	6,75
	lb			*12240	8910	8710	5860			7230	4890	(22.1)
1,5 m (4.9 ft)	kg			5900	3810	3840	2570			3130	2100	6,89
	lb			13010	8400	8470	5670			6900	4630	(22.6)
Boden- niveau	kg			5760	3690	3770	2500			3230	2160	6,70
	lb			12700	8140	8310	5510			7120	4760	(22.0)
-1,5 m (-4.9 ft)	kg	*9520	6800	5740	3670	3770	2500			3670	2440	6,13
	lb	*20990	14990	12650	8090	8310	5510			8090	5380	(20.1)
-3,0 m (-9.8 ft)	kg											
	lb											

Ausleger : 4,9 m (16' 1") / Löffelstiel : 1,9 m (6' 3") / Bodenplatten : 600 mm (24") 3-Stege-Bodenplatte / Heckgegengewicht : 2300 kg / Planierschild abgesenkt

Lasthöhe m (ft)	Lastradius								Max. Reichweite			
	3,0 m (9.8 ft)		4,5 m (14.8 ft)		6,0 m (19.7 ft)		7,5 m (24.6 ft)		Volumen	Reichweite		
											m (ft)	
7,5 m (24.6 ft)	kg									*4720	*4720	3,42
	lb									*10410	*10410	(11.2)
6,0 m (19.7 ft)	kg					*4060	*4060			*4310	3820	5,27
	lb					*8950	*8950			*9500	8420	(17.3)
4,5 m (14.8 ft)	kg	*5420	*5420	*4480	*4480	*4240	3100			*3980	2900	6,24
	lb	*11950	*11950	*9880	*9880	*9350	6830			*8770	6390	(20.5)
3,0 m (9.8 ft)	kg			*5550	4600	*4550	3020			*3940	2530	6,75
	lb			*12240	10140	*10030	6660			*8690	5580	(22.1)
1,5 m (4.9 ft)	kg			*6670	4360	*5030	2930			*4110	2400	6,89
	lb			*14700	9610	*11090	6460			*9060	5290	(22.6)
Boden- niveau	kg			*7270	4240	*5360	2860			*4560	2470	6,70
	lb			*16030	9350	*11820	6310			*10050	5450	(22.0)
-1,5 m (-4.9 ft)	kg	*9520	7930	*7220	4220	*5210	2870			*5030	2790	6,13
	lb	*20990	17480	*15920	9300	*11490	6330			*11090	6150	(20.1)
-3,0 m (-9.8 ft)	kg											
	lb											

Ausleger : 4,9 m (16' 1") / Löffelstiel : 1,9 m (6' 3") / Bodenplatten : 600 mm (24") 3-Stege-Bodenplatte / Heckgegengewicht : 2300 kg / Planierschild gehoben











Lasthöhe m (ft)	Lastradius								Max. Reichweite	
	3,0 m (9.8 ft)		4,5 m (14.8 ft)		6,0 m (19.7 ft)		7,5 m (24.6 ft)		Volumen	Reichweite
										

HUBVERMÖGEN











 Lastradius Frontauslage  Lastradius Seitenauslage bzw. 360 Grad

HX140L C 2-TEILIGER AUSLEGER











Ausleger : 4,9 m (16' 1") / Löffelstiel : 2,1 m (6' 11") / Bodenplatten : 600 mm (24") 3-Steg-Bodenplatte / Heckgegengewicht : 2300 kg / Ohne Planierschild

Lasthöhe m (ft)	Lastradius								Max. Reichweite		
	3,0 m (9.8 ft)		4,5 m (14.8 ft)		6,0 m (19.7 ft)		7,5 m (24.6 ft)		Volumen	Reichweite	
											m (ft)
7,5 m (24.6 ft)	kg								*4380	*4380	3,77
	lb								*9660	*9660	(12.4)
6,0 m (19.7 ft)	kg		*3810	*3810					*4110	3160	5,50
	lb		*8400	*8400					*9060	6970	(18.0)
4,5 m (14.8 ft)	kg	*5010	*5010	*4260	*4260	4030	2740		3580	2430	6,44
	lb	*11050	*11050	*9390	*9390	8880	6040		7890	5360	(21.1)
3,0 m (9.8 ft)	kg		*5340	4050	3940	2660			3150	2120	6,93
	lb		*11770	8930	8690	5860			6940	4670	(22.7)
1,5 m (4.9 ft)	kg		5900	3810	3830	2550			3000	2010	7,07
	lb		13010	8400	8440	5620			6610	4430	(23.2)
Boden- niveau	kg		5740	3670	3750	2480			3090	2060	6,88
	lb		12650	8090	8270	5470			6810	4540	(22.6)
-1,5 m (-4.9 ft)	kg	*9240	6730	5710	3640	3740	2470		3480	2310	6,33
	lb	*20370	14840	12590	8020	8250	5450		7670	5090	(20.8)
-3,0 m (-9.8 ft)	kg			5800	3720						
	lb			12790	8200						



Ausleger : 4,9 m (16' 1") / Löffelstiel : 2,1 m (6' 11") / Bodenplatten : 600 mm (24") 3-Steg-Bodenplatte / Heckgegengewicht : 2300 kg / Planierschild abgesenkt

Lasthöhe m (ft)	Lastradius								Max. Reichweite		
	3,0 m (9.8 ft)		4,5 m (14.8 ft)		6,0 m (19.7 ft)		7,5 m (24.6 ft)		Volumen	Reichweite	
											m (ft)
7,5 m (24.6 ft)	kg								*4380	*4380	3,77
	lb								*9660	*9660	(12.4)
6,0 m (19.7 ft)	kg		*3810	*3810					*4110	3570	5,50
	lb		*8400	*8400					*9060	7870	(18.0)
4,5 m (14.8 ft)	kg	*5010	*5010	*4260	*4260	*4050	3100		*3830	2760	6,44
	lb	*11050	*11050	*9390	*9390	*8930	6830		*8440	6080	(21.1)
3,0 m (9.8 ft)	kg		*5340	4610	*4410	3020			*3800	2420	6,93
	lb		*11770	10160	*9720	6660			*8380	5340	(22.7)
1,5 m (4.9 ft)	kg		*6500	4360	*4920	2910			*3980	2300	7,07
	lb		*14330	9610	*10850	6420			*8770	5070	(23.2)
Boden- niveau	kg		*7190	4220	*5300	2840			*4410	2360	6,88
	lb		*15850	9300	*11680	6260			*9720	5200	(22.6)
-1,5 m (-4.9 ft)	kg	*9240	7860	*7230	4190	*5260	2830		*4880	2650	6,33
	lb	*20370	17330	*15940	9240	*11600	6240		*10760	5840	(20.8)
-3,0 m (-9.8 ft)	kg			*6420	4270						
	lb			*14150	9410						

Ausleger : 4,9 m (16' 1") / Löffelstiel : 2,1 m (6' 11") / Bodenplatten : 600 mm (24") 3-Steg-Bodenplatte / Heckgegengewicht : 2300 kg / Planierschild gehoben











Lasthöhe m (ft)	Lastradius								Max. Reichweite		
	3,0 m (9.8 ft)		4,5 m (14.8 ft)		6,0 m (19.7 ft)		7,5 m (24.6 ft)		Volumen	Reichweite	
											m (ft)
7,5 m (24.6 ft)	kg								*4380	*4380	3,77
	lb								*9660	*9660	(12.4)
6,0 m (19.7 ft)	kg		*3810	*3810					*4110	3320	5,50
	lb		*8400	*8400					*9060	7320	(18.0)
4,5 m (14.8 ft)	kg	*5010	*5010	*4260	*4260	4030	2880		3580	2560	6,44
	lb	*11050	*11050	*9390	*9390	8880	6350		7890	5640	(21.1)
3,0 m (9.8 ft)	kg		*5340	4260	3940	2800			3140	2240	6,93
	lb		*11770	9390	8690	6170			6920	4940	(22.7)
1,5 m (4.9 ft)	kg		5890	4010	3830	2690			3000	2130	7,07
	lb		12990	8840	8440	5930			6610	4700	(23.2)
Boden- niveau	kg		5730	3870	3750	2620			3090	2180	6,88
	lb		12630	8530	8270	5780			6810	4810	(22.6)
-1,5 m (-4.9 ft)	kg	*9240	7100	5700	3840	3740	2610		3480	2440	6,33
	lb	*20370	15650	12570	8470	8250	5750		7670	5380	(20.8)
-3,0 m (-9.8 ft)	kg			5790	3920						
	lb			12760	8640						

HUBVERMÖGEN











 Lastradius Frontauslage  Lastradius Seitenauslage bzw. 360 Grad

HX140L C 2-TEILIGER AUSLEGER

Ausleger : 4,9 m (16' 1") / Löffelstiel : 2,5 m (8' 2") / Bodenplatten : 600 mm (24") 3-Steg-Bodenplatte / Heckgegengewicht : 2300 kg / Ohne Planierschild

Lasthöhe m (ft)	Lastradius								Max. Reichweite		
	3,0 m (9.8 ft)		4,5 m (14.8 ft)		6,0 m (19.7 ft)		7,5 m (24.6 ft)		Volumen	Reichweite	
											m (ft)
7,5 m (24.6 ft)	kg										
	lb										
6,0 m (19.7 ft)	kg			*3500	*3500						4,50
	lb			*7720	*7720						(14.8)
4,5 m (14.8 ft)	kg		*3340	*3340	*2970	2760			*2890	2750	6,01
	lb		*7360	*7360	*6550	6080			*6370	6060	(19.7)
3,0 m (9.8 ft)	kg		*3840	*3840	*3710	2760			*2680	2180	6,88
	lb		*8470	*8470	*8180	6080			*5910	4810	(22.6)
1,5 m (4.9 ft)	kg		*4930	4090	3950	2660			*2640	1930	7,35
	lb		*10870	9020	8710	5860			*5820	4250	(24.1)
Boden- niveau	kg		5920	3820	3820	2540			*2740	1840	7,48
	lb		13050	8420	8420	5600			*6040	4060	(24.5)
-1,5 m (-4.9 ft)	kg	*4510	*4510	5720	3640	3720	2450		2820	1870	7,30
	lb	*9940	*9940	12610	8020	8200	5400		6220	4120	(23.9)
-3,0 m (-9.8 ft)	kg	*8370	6630	5650	3590	3690	2420		3120	2070	6,78
	lb	*18450	14620	12460	7910	8140	5340		6880	4560	(22.3)
	kg	*9850	6750	5710	3640				3910	2580	5,84
	lb	*21720	14880	12590	8020				8620	5690	(19.2)

Ausleger : 4,9 m (16' 1") / Löffelstiel : 2,5 m (8' 2") / Bodenplatten : 600 mm (24") 3-Steg-Bodenplatte / Heckgegengewicht : 2300 kg / Planierschild abgesenkt











Lasthöhe m (ft)	Lastradius								Max. Reichweite		
	3,0 m (9.8 ft)		4,5 m (14.8 ft)		6,0 m (19.7 ft)		7,5 m (24.6 ft)		Volumen	Reichweite	
											m (ft)
7,5 m (24.6 ft)	kg										
	lb										
6,0 m (19.7 ft)	kg			*3500	*3500				*3500	*3500	4,50
	lb			*7720	*7720				*7720	*7720	(14.8)
4,5 m (14.8 ft)	kg		*3340	*3340	*2970	*2970			*2890	*2890	6,01
	lb		*7360	*7360	*6550	*6550			*6370	*6370	(19.7)
3,0 m (9.8 ft)	kg		*3840	*3840	*3710	3130			*2680	2480	6,88
	lb		*8470	*8470	*8180	6900			*5910	5470	(22.6)
1,5 m (4.9 ft)	kg		*4930	4650	*4140	3030			*2640	2200	7,35
	lb		*10870	10250	*9130	6680			*5820	4850	(24.1)
Boden- niveau	kg		*6170	4370	*4710	2910			*2740	2110	7,48
	lb		*13600	9630	*10380	6420			*6040	4650	(24.5)
-1,5 m (-4.9 ft)	kg	*4510	*4510	*7010	4190	*5170	2810		*2990	2150	7,30
	lb	*9940	*9940	*15450	9240	*11400	6190		*6590	4740	(23.9)
-3,0 m (-9.8 ft)	kg	*8370	7750	*7230	4140	*5290	2780		*3490	2370	6,78
	lb	*18450	17090	*15940	9130	*11660	6130		*7690	5220	

HUBVERMÖGEN











 Lastradius Frontauslage  Lastradius Seitenauslage bzw. 360 Grad

HX140HW C

Ausleger : 4,6 m (15' 1") / Löffelstiel : 1,9 m (6' 3") / Bodenplatten : 800 mm (32") 3-Step-Bodenplatte / Heckgegengewicht : 2000 kg

Lasthöhe m (ft)	Lastradius								Max. Reichweite		
	1,5 m (4.9 ft)		3,0 m (9.8 ft)		4,5 m (14.8 ft)		6,0 m (19.7 ft)		Volumen	Reichweite	
											
6,0 m (19.7 ft)	kg				*4200	*4200			*3650	*3650	4,73
	lb				*9260	*9260			*8050	*8050	(15.5)
4,5 m (14.8 ft)	kg				*4330	*4330			*3340	3080	5,80
	lb				*9550	*9550			*7360	6790	(19.0)
3,0 m (9.8 ft)	kg				*5220	4380	4310	2880	*3330	2640	6,35
	lb				*11510	9660	9500	6350	*7340	5820	(20.8)
1,5 m (4.9 ft)	kg				*6220	4170	4220	2800	*3540	2500	6,50
	lb				*13710	9190	9300	6170	*7800	5510	(21.3)
Boden- niveau	kg		*5750	*5750	6350	4050	4160	2750	3900	2580	6,29
	lb		*12680	*12680	14000	8930	9170	6060	8600	5690	(20.6)
-1,5 m (-4.9 ft)	kg	*5700	*5700	*9710	7400	6330	4030		4500	2960	5,68
	lb	*12570	*12570	*21410	16310	13960	8880		9920	6530	(18.6)
-3,0 m (-9.8 ft)	kg			*7880	7560	*5100	4150		*5080	4140	4,51
	lb			*17370	16670	*11240	9150		*11200	9130	(14.8)



Ausleger : 4,6 m (15' 1") / Löffelstiel : 2,1 m (6' 11") / Bodenplatten : 800 mm (32") 3-Step-Bodenplatte / Heckgegengewicht : 2000 kg

Lasthöhe m (ft)	Lastradius								Max. Reichweite		
	1,5 m (4.9 ft)		3,0 m (9.8 ft)		4,5 m (14.8 ft)		6,0 m (19.7 ft)		Volumen	Reichweite	
											
6,0 m (19.7 ft)	kg				*3910	*3910			*3470	*3470	4,97
	lb				*8620	*8620			*7650	*7650	(16.3)
4,5 m (14.8 ft)	kg				*4120	*4120			*3210	2930	5,99
	lb				*9080	*9080			*7080	6460	(19.7)
3,0 m (9.8 ft)	kg		*7310	*7310	*5030	4390	*4280	2870	*3220	2530	6,52
	lb		*16120	*16120	*11090	9680	*9440	6330	*7100	5580	(21.4)
1,5 m (4.9 ft)	kg				*6070	4170	4210	2790	*3430	2400	6,67
	lb				*13380	9190	9280	6150	*7560	5290	(21.9)
Boden- niveau	kg		*6160	*6160	6330	4030	4140	2730	3730	2470	6,47
	lb		*13580	*13580	13960	8880	9130	6020	8220	5450	(21.2)
-1,5 m (-4.9 ft)	kg	*5500	*5500	*9870	7340	6300	4000		4260	2800	5,88
	lb	*12130	*12130	*21760	16180	13890	8820		9390	6170	(19.3)
-3,0 m (-9.8 ft)	kg			*8230	7490	*5470	4090		*5000	3800	4,75
	lb			*18140	16510	*12060	9020		*11020	8380	(15.6)

1. Die Hublast richtet sich nach der Definition in SAE J1097 und ISO 10567.
2. Die Hublast der Serie HX darf auf festem, ebenem Untergrund maximal 75 % der Kipplast der Maschine bzw. 87 % der gesamten hydraulischen Hubkraft betragen.











3. Der Lasthaken befindet sich an der Rückseite des Tieflöffels.
4. (*) gibt die Lastbegrenzung durch die hydraulische Hubkraft an.

HUBVERMÖGEN











 Lastradius Frontauslage  Lastradius Seitenauslage bzw. 360 Grad

HX140HW C

Ausleger : 4,6 m (15' 1") / Löffelstiel : 2,5 m (8' 2") / Bodenplatten : 800 mm (32") 3-Step-Bodenplatte / Heckgegengewicht : 2000 kg

Lasthöhe m (ft)	Lastradius								Max. Reichweite				
	1,5 m (4.9 ft)		3,0 m (9.8 ft)		4,5 m (14.8 ft)		6,0 m (19.7 ft)		Volumen	Reichweite			
													
6,0 m (19.7 ft)	kg					*3400	*3400		*2390	*2390	5,50		
	lb					*7500	*7500		*5270	*5270	(18.0)		
4,5 m (14.8 ft)	kg					*3700	*3700	*3500	2950	*2210	*2210	6,44	
	lb					*8160	*8160	*7720	6500	*4870	*4870	(21.1)	
3,0 m (9.8 ft)	kg					*6380	*6380	*4630	4420	*4000	2880	6,93	
	lb					*14070	*14070	*10210	9740	*8820	6350	(22.7)	
1,5 m (4.9 ft)	kg					*7050	*7050	*5760	4170	4200	2780	7,07	
	lb					*15540	*15540	*12700	9190	9260	6130	(23.2)	
Boden- niveau	kg					*6550	*6550	6320	4010	4120	2700	6,88	
	lb					*14440	*14440	13930	8840	9080	5950	(22.6)	
-1,5 m (-4.9 ft)	kg	*4890	*4890	*10080	7250	6250	3950		4090	2680	*3160	2500	6,34
	lb	*10780	*10780	*22220	15980	13780	8710		9020	5910	*6970	5510	(20.8)
-3,0 m (-9.8 ft)	kg	*9020	*9020	*8820	7370	*5920	4000				*4580	3210	5,31
	lb	*19890	*19890	*19440	16250	*13050	8820				*10100	7080	(17.4)

Ausleger : 4,6 m (15' 1") / Löffelstiel : 3,0 m (9' 10") / Bodenplatten : 800 mm (32") 3-Step-Bodenplatte / Heckgegengewicht : 2000 kg

Lasthöhe m (ft)	Lastradius								Max. Reichweite					
	1,5 m (4.9 ft)		3,0 m (9.8 ft)		4,5 m (14.8 ft)		6,0 m (19.7 ft)		Volumen	Reichweite				
														
6,0 m (19.7 ft)	kg							*2230	*2230	*2000	*2000	6,08		
	lb							*4920	*4920	*4410	*4410	(20.0)		
4,5 m (14.8 ft)	kg							*3280	2990	*1880	*1880	6,94		
	lb							*7230	6590	*4140	*4140	(22.8)		
3,0 m (9.8 ft)	kg							*5250	*5250	*4130	*4130	7,40		
	lb							*11570	*11570	*9110	*9110	(24.3)		
1,5 m (4.9 ft)	kg							*8390	7730	*5340	4220	7,53		
	lb							*18500	17040	*11770	9300	(24.7)		
Boden- niveau	kg							*7180	*7180	*6290	4020	4110	2690	7,36
	lb							*15830	*15830	*13870	8860	9060	5930	(24.1)
-1,5 m (-4.9 ft)	kg	*4370	*4370	*9280	7200	6220	3920		4050	2640	*2610	2220	6,85	
	lb	*9630	*9630	*20460	15870	13710	8640		8930	5820	*5750	4890	(22.5)	
-3,0 m (-9.8 ft)	kg	*7550	*7550	*9420	7270	6240	3930				*3560	2730	5,91	
	lb	*16640	*16640	*20770	16030	13760	8660				*7850	6020	(19.4)	

1. Die Hublast richtet sich nach der Definition in SAE J1097 und ISO 10567.
2. Die Hublast der Serie HX darf auf festem, ebenem Untergrund maximal 75 % der Kipplast der Maschine bzw. 87 % der gesamten hydraulischen Hubkraft betragen.

3. Der Lasthaken befindet sich an der Rückseite des Tieflöffels.
4. (*) gibt die Lastbegrenzung durch die hydraulische Hubkraft an.

MOTOR	STD	OPT
Cummins QSF 3.8	●	
HYDRAULIKSYSTEM	STD	OPT
IPC (Intelligent Power Control)		
3 Leistungsstufen, 2 Arbeitsarten, Benutzermodus	●	
Variable Leistungssteuerung	●	
Pumpenfördermengenregelung	●	
Volumenstromregelung für Anbaugerät-Betriebsart		●
Automatischer Motorleerlauf	●	
Automatische Motorabschaltung		●
KABINE UND INNENRAUM	STD	OPT
Kabine nach ISO-Norm		
Obenrunder Frontscheibenwischer	●	
Radio/USB-Player	●	
Mobiltelefon-Freisprecheinrichtung mit USB	●	
12-Volt-Steckdose (Wandler 24 VDC auf 12 VDC)	●	
Elektrisches Signalhorn	●	
Allwetter-Stahlkabine mit 360°-Rundumsicht	●	
Sicherheitsglasscheiben	●	
Frontscheibe einschiebbar	●	
Seitenscheibe (links) als Schiebefenster	●	
Abschließbare Tür	●	
Warmhalte- und Kühlbox	●	
Aufbewahrungsfach und Aschenbecher	●	
Kabinendachabdeckung transparent	●	
Sonnenblende	●	
Tür- und Kabinenschlösser, ein Schlüssel	●	
Mechanisch gefederter, beheizter Sitz	●	
Vorsteuerdruckunterstützter Joystick	●	
Konsole höhenverstellbar	●	
Automatische Klimaregelung		
Klimaanlage und Heizung	●	
Scheibenheizung	●	
Starthilfe (Ansaugluftvorwärmung) bei kalten Temperaturen	●	
Zentrale Überwachung		
8-Zoll-LCD	●	
Motordrehzahl oder Tageszähler/Beschleunigung	●	
Motorkühlmittel-Temperaturanzeige	●	
Max. Leistung	●	
Kriechgang/Schnellgang	●	
Automatischer Leerlauf	●	
Überlast	●	
Motor überprüfen	●	
Luftfilter verstopft	●	
Anzeigen	●	
ÖKO-Anzeigen	●	
Kraftstoffstandanzeige	●	
Anzeige für die Hydrauliköltemperatur	●	
Kraftstoffvorwärmer	●	
Warnungen	●	
Kommunikationsfehler	●	
Batterie niedrig	●	
Uhr	●	
Kabinenscheinwerfer		●
Regenschutz für Kabinenfrontfenster		●
Kabinendachabdeckung in Stahl		●
Sitz		
Einstellbarer Fahrersitz mit Luftfederung und Heizung		●
Kabinen-FOPS/FOG		
FOPS (Schutzeinrichtung gegen herabfallende Gegenstände) - ISO 3449 Stufe 2		●
FOG (Schutzaufbau gegenherabfallende Gegenstände) - ISO/DIS 10262 Stufe 2	Fahrerschutz vorn und oben	●
	Fahrerschutz oben	●
Kabinen-ROPS		
ROPS (Überrollschutz) - ISO 12117-2	●	

SICHERHEIT	STD	OPT
Batterie Hauptschalter	●	
Heckkamera	●	
Kameragestützte virtuelle Draufsicht incl. Bewegtbildüberwachung (AAVM + MOD)		●
Rechte Seitenkamera		●
Vier vordere Arbeitsscheinwerfer (2 am Ausleger montiert, 2 am vorderen Rahmen montiert)	●	
Fahralarm		●
Arbeitsscheinwerfer hinten		●
Rundumleuchte		●
Automatische Schwenkbremse	●	
Auslegerhaltesystem	●	
Stielhaltesystem	●	
Sicherheitsventil für Auslegerzylinder mit Überlastwarnrichtung		●
Sicherheitsventil für Löffelstielzylinder		●
Schwenksperre		●
2 Außenrückspiegel	●	

SONSTIGES	STD	OPT
-----------	-----	-----

Ausleger		
4,1 m; 13' 5" Mono-Ausleger		●
4,6 m; 15' 1" Mono-Ausleger	●	
4,9 m; 16' 9" 2-teiliger Ausleger		●
Löffelstiel		
1,9 m; 6' 3"		●
2,1 m; 6' 11"		●
2,5 m; 8' 2"	●	
3,0 m; 9' 10"		●
Herausnehmbares Kühlerstaubgitter	●	
Herausnehmbarer Vorratsbehälter	●	
Kraftstoffvorfilter	●	
Kraftstoffvorwärmer		●
Selbstdiagnosesystem	●	
	Mobiltelefon	●
Hi MATE (Maschinenmanagementsystem)	Satellit	●
	Dual	●
Batterien (2 x 12 V x 100 Ah)	●	
Kraftstoffeinfüllpumpe (50 l/min) mit automatischer Abschaltung		●
Einfach wirkende Verrohrung (Hydraulikhammer usw.)		●
Doppelt wirkende Verrohrung (Zweischalengreifer usw.)	●	
Verrohrung für drehende Anbaugeräte		●
Verrohrung für hydraulische Schnellwechsler		●
Schnellwechsler		●
Auslegerschwimmsteuerung		●
Druckspeicher beim Senken der Arbeitseinrichtung	●	
Bedienschema-Umschaltventil (2 Muster)		●
Feinsteuerung Schwenken		●
Werkzeugatz		●

UNTERWAGEN	STD	OPT
------------	-----	-----

Unterbodenschutz Unterwagen (extra)		●
Unterbodenschutz Unterwagen (normal)	●	
Planierschild		●
Bodenplatten		
3-Steg-Bodenplatte shoes (600 mm; 24")	●	
3-Steg-Bodenplatte shoes (700 mm; 28")		●
3-Steg-Bodenplatte shoes (800 mm; 32")		●
2-Steg-Bodenplatten (700 mm; 28")		●
Laufrollenschutz	●	
Die vollständige Laufrollenschutz		●

STD = Standard
OPT = Optional

- * Standard- und Wahlausstattung können je nach Modell abweichen. Weitere Informationen erhalten Sie von Ihrem Hyundai-Händler. Die Maschinenausstattung kann von internationalen Normen abhängig sein.
- * Auf den Fotos können Anbauten und optionale Geräte abgebildet sein, die in Ihrer Region nicht erhältlich sind.
- * Änderungen der Materialien und technischen Daten vorbehalten.
- * Alle Maße in angloamerikanischen Maßeinheiten sind auf das nächste volle Maß (Pound oder Zoll) gerundet.
- * Die Klimaanlage für die Maschine enthält das fluoridierte Treibhausgas mit einem Treibhauspotenzial von R134a. (Treibhauspotenzial: 1430) Das System enthält 0,65 kg Kältemittel, was einem CO₂-Äquivalent von 0,93 kg (metrische Tonne) entspricht. Weitere Informationen können Sie dem Handbuch entnehmen.



BITTE KONTAKTIEREN SIE

Hyundai Construction Equipment Europe nv

Hyundailaan 4, 3980 Tessenderlo, Belgium Tel: (32) 14-56-2200 Fax: (32) 14-59-3405 www.hyundai.eu

DE - 2018.09 Rev 0